

# FM 23-12

DEPARTMENT OF THE ARMY FIELD MANUAL

---

## TECHNIQUE OF FIRE OF THE RIFLE SQUAD AND TACTICAL APPLICATION



HEADQUARTERS, DEPARTMENT OF THE ARMY  
MAY 1963

FM 23-12 }  
CHANGE NO. 1 }

HEADQUARTERS  
DEPARTMENT OF THE ARMY  
WASHINGTON, D. C., 23 February 1965

FIELD MANUAL

TECHNIQUE OF FIRE OF THE RIFLE SQUAD AND TACTICAL APPLICATION

FM 23-12, 27 May 1963, is changed as follows:

**12. Trajectory, Danger Space, Cone of Fire, Beaten Zone, and Casualty Radius**

\* \* \* \* \*

*b. Danger Space.* This is the space between the firer and the target where the trajectory does not rise above the height of an average standing man, and the area of the beaten zone (*d* below).

\* \* \* \* \*

*d. Beaten Zone.* The area where \*\*\* will be shorter. As the range to the target increases out to 500 meters, the beaten zone will become longer and wider (figs. 7 and 10). Beyond 500 meters the beaten zone will become shorter and wider. An understanding of \*\*\* from their fires.

\* \* \* \* \*

**18. Application of Fire on a Column Target**

(Superseded) Unless the column target is obvious, the squad leader designates its center, front, and rear. Each team leader distributes his fire on one-half of the target (fig. 15).

*a. Rifleman.* (Superseded) Each Rifleman fires rapidly on approximately one-third of the target, distributing fire in depth on his portion of the target (fig. 15.1). If the enemy column changes formation or disperses, the rifleman distribute their fires as directed.

\* \* \* \* \*

**22. Assault Fire (Day)**

(Superseded) Assault fire may be delivered by the rifle squad during the final phase of an attack. During the assault, squad members fire

as rapidly as possible consistent with their ability to place effective fire on the objective.

\* \* \* \* \*

*b. Automatic Riflemen.* The automatic riflemen \*\*\* enemy automatic weapons. Fires of the automatic rifleman are distributed over their respective halves of the squad objective.

\* \* \* \* \*

**43. Application of Fire**

Normally, only two \*\*\* fires on order.

*a. Visible Target.* In order to \*\*\* techniques are applied.

\* \* \* \* \*

(2) *Automatic riflemen.* The primary targets \*\*\* assaulting enemy personnel. Automatic riflemen fire at assaulting enemy personnel first if they pose a greater threat to the squad than enemy automatic weapons.

(3) *Grenadiers.* The primary target \*\*\* enemy automatic weapons. In order for their fire to be effective against muzzle flash targets, the grenadiers must have sufficient visibility to either determine the range and adjust their fires or their fires must be preplanned. In the absence of primary targets or sufficient visibility, the grenadiers fire at assaulting enemy personnel, using the pointing technique. The grenadiers fire at assaulting enemy personnel first if they pose a greater threat to the squad than enemy automatic weapons.

\* \* \* \* \*

**51. Night Application Firing Exercises**

\* \* \* \* \*

*c. Conduct of Training.*

Property of  
Office of the Chief  
Military History  
General Reference Branch 1

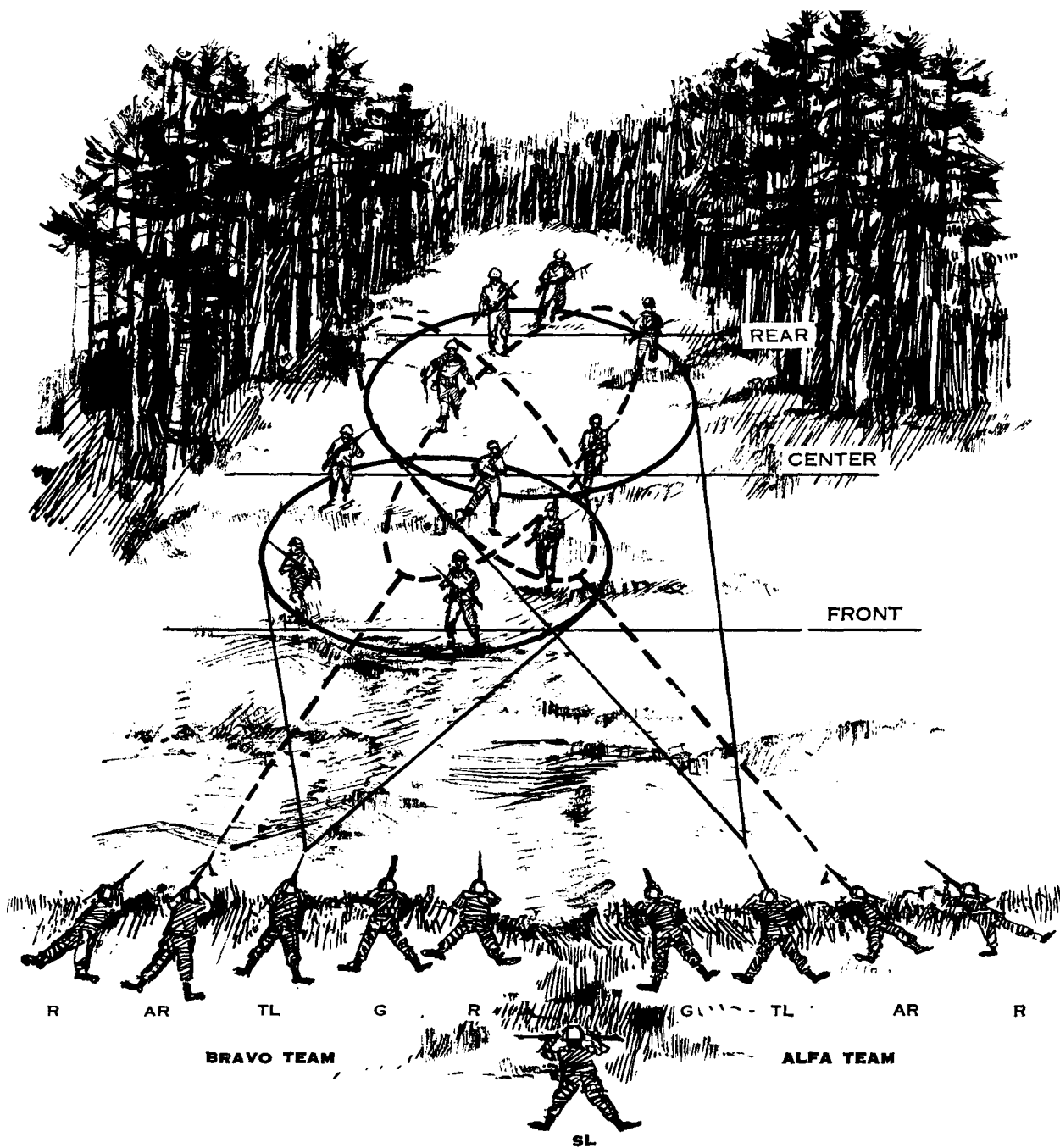


Figure 15 (Superseded). Application of fire by team leaders and automatic riflemen on a column target.

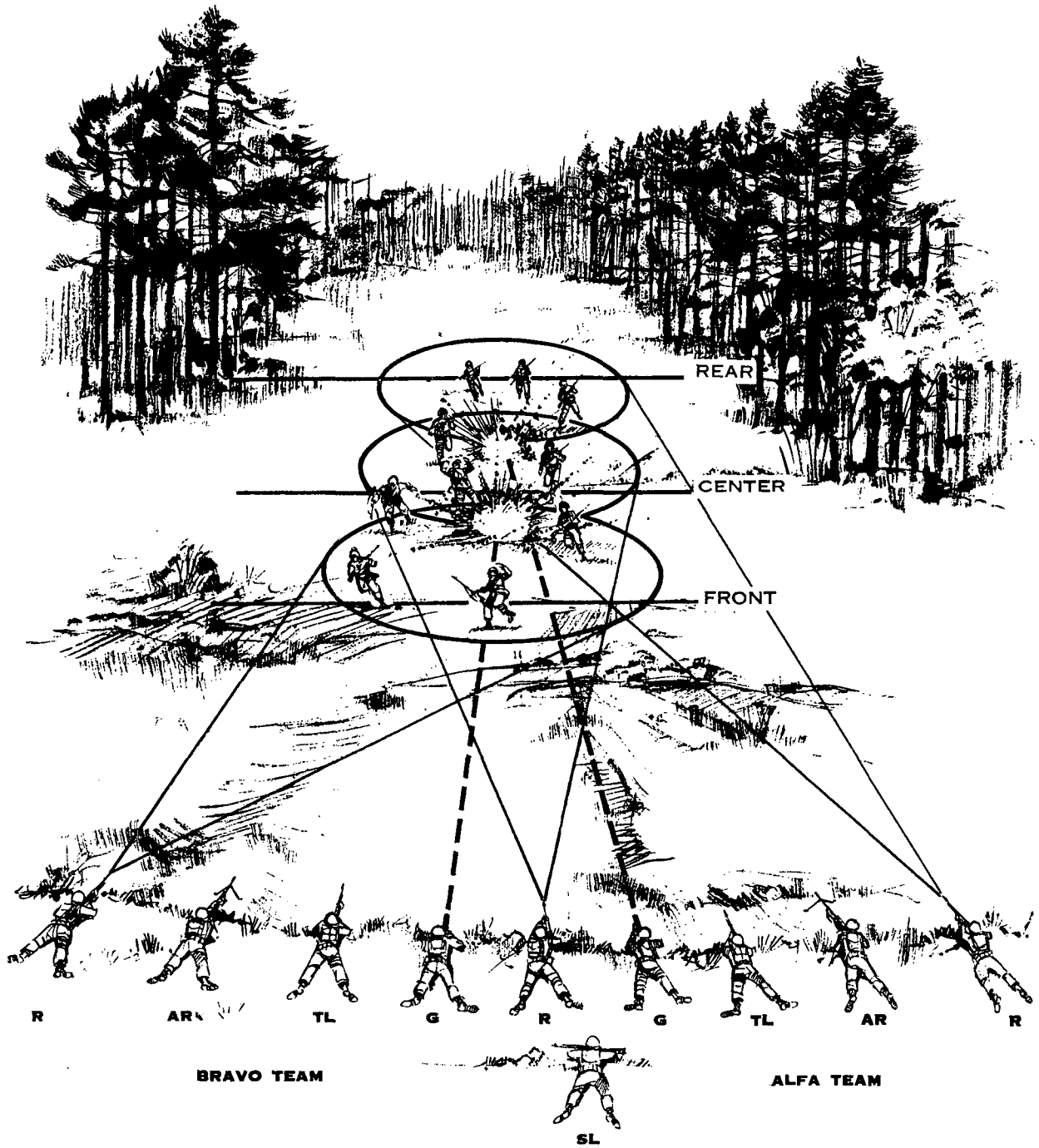


Figure 15.1 (Added). Application of fire by grenadiers and riflemen on a column target.

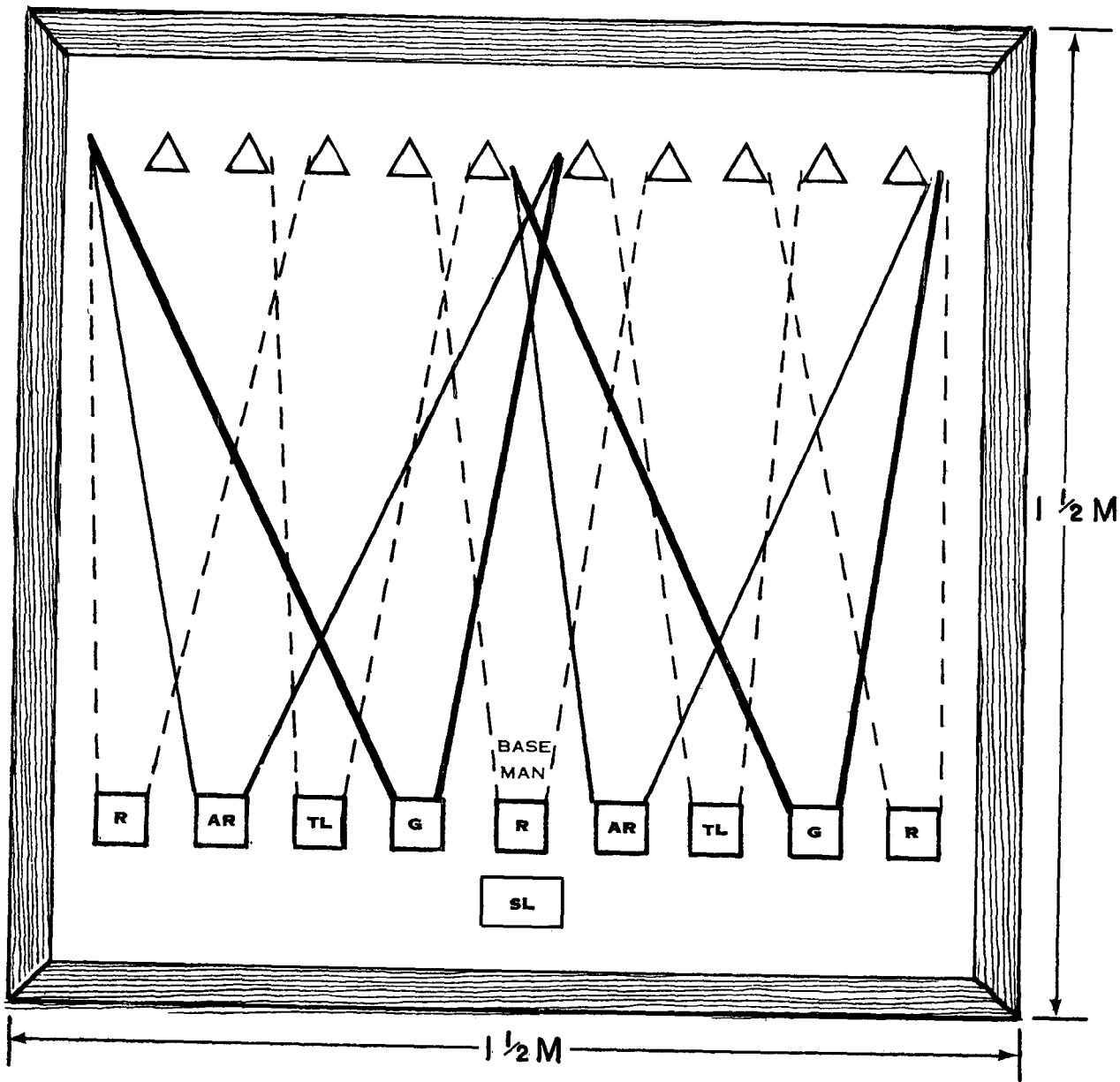


Figure 83 (Superseded). Assault fire distribution.

(4) Starting with the squad \*\*\* the following sequence:

(d) After the squad's \*\*\* using appropriate techniques.

Note. (Added) If the limit of visibility is less than 40 meters, the squad is ordered to deliver preplanned fires to begin the exercise. Only the 40-meter tar-

gets are used. After delivery of preplanned fires, the remaining exercises are fired as described in (d) above and (e) below.

(e) Just prior to \*\*\* squad's fire discipline. While the squad \*\*\* to cease fire.

### 61. Distributing Fire

To insure that \*\*\* techniques are applied:

a. Team leaders and \*\*\* in the squad. If there are no indications of resistance in their portions, they may fire as far to the left and right as safety permits in order to concentrate fire on known or suspected enemy positions.

b. (Superseded) Automatic riflemen distribute their fires over their respective halves of the squad objective, giving priority to enemy automatic weapons.

c. (Superseded) Grenadiers distribute their fires over their respective halves of the squad objective, giving priority to enemy automatic weapons.

\* \* \* \* \*

By Order of the Secretary of the Army:

Official:

J. C. LAMBERT,  
Major General, United States Army,  
The Adjutant General.

Distribution:

Active Army:

DCSPER (2)  
DCSLOG (2)  
DCSOPS (2)  
ACSI (2)  
CNGB (2)  
CORC (2)  
CRD (1)  
COA (1)  
CINFO (1)  
TIG (1)  
USAMC (5)  
USACDC (10)  
USCONARC (20)  
ARADCOM (2)  
ARADCOM Rgn (2)  
LOGCOMD (1)  
TJAGSA (1)  
PMGS (1)

MFSS (1)  
USAOC&S (1)  
USAES (1)  
USAQMS (1)  
USATSCH (1)  
USASCS (1)  
USACMLCS (1)  
USACHS (1)  
Armies (5)  
Corps (3)  
Div (10)  
Div Arty (1)  
Bde (5)  
Regt/Gp (1)  
Inf bat gp (5)  
Co/btry (5)  
Bn (5)

NG: State AG (3); units—same as Active Army except allowance is one (1) copy to each unit.

USAR: Same as Active Army.

For explanation of abbreviations used, see AR 320-50.

## 62. General

Squad assault night firing instruction consists of two phases: the DAY Instruction Phase and the NIGHT Application Phase, both of which are presented in one day. This instruction should \*\*\* night firing instruction.

a. *The Day Instruction Phase* consists of a conference and a series of practical exercises. During the conference, the squads are taught the techniques described in paragraphs 57 through 61. The practical work \*\*\* techniques are stressed.

b. *The Night Application Phase* is a live fire exercise which requires the squads to apply what they learned during the instruction phase.

HAROLD K. JOHNSON,  
General, United States Army,  
Chief of Staff.

FIELD MANUAL }  
 No. 23-12 }

HEADQUARTERS,  
 DEPARTMENT OF THE ARMY  
 WASHINGTON 25, D.C., 27 May 1963

## TECHNIQUE OF FIRE OF THE RIFLE SQUAD AND TACTICAL APPLICATION

	Paragraphs	Page
<b>CHAPTER 1. INTRODUCTION</b> .....	1-3	3
<b>2. FUNDAMENTALS OF TECHNIQUE OF FIRE (DAY)</b>		
Section I. Introduction.....	4, 5	6
II. Range determination.....	6-10	6
III. Characteristics of rifle, automatic rifle, and grenade launcher fire.....	11-13	9
IV. Application of fire.....	14-22	15
V. Fire control.....	23-28	22
<b>CHAPTER 3. FIELD AND LANDSCAPE TARGET FIRING</b>		
Section I. Introduction.....	29, 30	28
II. Field target firing.....	31-33	28
III. Landscape target firing.....	34-38	37
<b>CHAPTER 4. TECHNIQUE OF FIRE DURING PERIODS OF LIMITED VISIBILITY</b>		
Section I. Introduction.....	39, 40	42
II. Fundamentals of squad defensive night firing.....	41-46	42
III. Squad defensive night firing instruction.....	47-52	48
IV. Squad defensive night firing proficiency course.....	53-55	53
V. Fundamentals of squad assault night firing.....	56-61	53
VI. Squad assault night firing instruction.....	62-67	57
VII. Squad assault night firing proficiency course.....	68-70	61
<b>CHAPTER 5. TACTICAL APPLICATION</b>		
Section I. Introduction.....	71, 72	63
II. Definitions.....	73-75	63
III. Squad formations.....	76-79	66
IV. Arm-and-hand signals.....	80, 81	71
V. Rifle squad in defense.....	82-85	72
VI. Rifle squad in the attack.....	86-91	92
<b>APPENDIX I. REFERENCES</b> .....		101
<b>II. AMMUNITION REQUIREMENTS</b> .....		102
<b>III. SAFETY</b> .....		104
<b>IV. TRAINING AIDS</b> .....		107
<b>V. TRAINING DEVICES</b> .....		114
<b>INDEX</b> .....		128





# CHAPTER 1

## INTRODUCTION

---

### 1. Purpose and Scope

a. This manual is a guide for training in the principles and methods of training in technique of fire of the rifle squad. It covers fundamentals of daytime technique of fire, field and landscape target firing, technique of fire during periods of limited visibility, and the tactical application of technique of fire. It also includes a description of the training aids, targets, training devices, and range facilities required for this training, and suggests methods of presenting the instruction.

b. The material presented herein is applicable without modification to both nuclear and nonnuclear warfare.

c. Users of this manual are encouraged to submit changes or comments to improve the manual. Comments should be keyed to the specific page, paragraph, and line of the text in which the change is recommended. Reasons should be provided for each comment to insure understanding and complete evaluation. Comments should be forwarded directly to the Commandant, United States Army Infantry School, Fort Benning, Ga.

### 2. The Rifle Squad

a. *General.* The rifle squad is the basic infantry fire unit. Its equipment, organization, and training enable it to operate effectively in widely varying conditions of visibility, weather, and terrain.

b. *Organization of the Rifle Squad.* The rifle squad consists of the squad leader and two fire teams. These teams are designated as ALFA and BRAVO teams. The ALFA team consists of a team leader, one automatic rifleman, one grenadier, and one rifleman. The BRAVO team is organized the same, except it has one more rifleman.

c. *Duties of Members of the Rifle Squad.* Each man in the squad has definite primary

duties. Above all, each man must be effective in the performance of his duties as an individual in order to contribute to the accomplishment of the overall tactical mission of his unit. A spirit of teamwork and confidence in each member of the team develops cohesion within the fire team and squad, enhances morale, and produces aggressive and effective action in combat. Every man in the fire team must know and understand the duties and responsibilities of every other member of the fire team. He must be prepared to assume any of these duties and responsibilities when necessary. Likewise, the fire team leaders must know and understand the duties of the squad leader.

(1) *Squad leader.* The squad leader carries out the orders issued to him by the platoon leader. He is responsible for the discipline, appearance, training, control, and conduct of his squad at all times, and for the condition and care of its weapons and equipment. In combat, he is also responsible for the fire discipline, fire control, and maneuver of his squad. He positions himself where he can best carry out the orders of the platoon leader and observe and control the squad. He engages in a fire fight only in very critical situations.

(2) *Fire team leader.* The fire team leader leads the fire team primarily by example. He carries out the orders of the squad leader for the employment of his fire team to include its fire discipline and fire control. He positions himself where he can best carry out the orders of the squad leader in controlling the fire team. He should be close enough to the automatic rifleman and grenadier to enable him to best exercise control of these weapons quickly and effectively. In addition to

his primary duties, he acts as a rifleman. The senior fire team leader commands the squad in the squad leader's absence.

- (3) *Automatic riflemen, grenadiers, and riflemen.* The automatic riflemen, grenadiers, and riflemen are responsible for engaging appropriate targets using prescribed SOP's and techniques. They watch for ways to assist the squad by using the firepower of their weapons. They watch for new targets and point them out to the squad and team leaders. They keep alert for orders from the squad and team leaders and transmit orders from them to other squad members. The riflemen assist the automatic riflemen and grenadiers in adjusting fire on targets when the situation permits. If any of the automatic riflemen or grenadiers become casualties, the riflemen must be prepared to take their place.

### 3. Training

*a. Basis.* The doctrine and training covered by this manual are based upon the following fundamental principles.

- (1) Most combat targets consist of a number of men or objects irregularly deployed and using cover such as ground folds, hedges, and borders of woods or ditches.
- (2) Most combat targets are detected by smoke, flash, dust, noise, or movement and are usually seen only fleetingly.
- (3) Enemy personnel targets are rarely visible except in a close assault.
- (4) The range of battlefield targets will rarely exceed 300 meters; however, the squad must be capable of engaging targets out to the maximum effective range of the weapons of the squad.
- (5) When engaging enemy targets, the squad members are under stress caused by fear, fatigue, hardship, and battlefield noise.
- (6) Squad members must engage both visible and invisible combat targets of varying dimensions within their sector of fire.

- (7) In certain situations, squad fire will be initiated and sustained without direction from the squad leader.
- (8) The successful engagement of targets depends on the effective application and control of fire.
- (9) The differences between day and night techniques must be kept to a minimum and the squad must be as effective at night as it is in daylight.

*b. Prerequisites.* Before the soldier undergoes training in daytime technique of fire of the rifle squad, he must have completed his individual rifle marksmanship training. Prior to conducting technique of fire training during periods of limited visibility, the squad members must have completed their automatic rifle and grenade launcher marksmanship training.

*c. Objectives.* Technique of fire training is designed to—

- (1) Develop the individual soldier's ability to function as a member of a fire unit in the engagement of combat type targets in the attack and defense.
- (2) Train rifle squads to act as effective teams in the application and control of their collective fire.

*d. Characteristics.* Technique of fire training is characterized by—

- (1) Extensive training in the development of standing operating procedures which will:
  - (a) Allow the individual rifleman to react automatically without orders.
  - (b) Assist the squad leader and fire team leaders in controlling and directing their men more efficiently in combat.
  - (c) Provide leaders more time to concentrate on matters arising during crucial moments of combat.
- (2) Presenting realistic targets at combat ranges during live fire exercises.
- (3) Simulating the sights and sounds of the enemy during live fire exercises by the use of targets and devices.
- (4) Objectively scoring all live fire exercises so the squad's performance can be evaluated.

- (5) Conducting training in related subjects concurrently or by integrating them into live fire exercises.

*e. Conduct.*

- (1) Technique of fire training consists of conferences, demonstrations, and practical exercises. It makes extensive use of live fire exercises. The success of the training depends on the competence and ingenuity of the instructors and assistant instructors.
- (2) Whenever possible, the live fire exercises should be conducted in a tactical setting. Basic squad tactics should be taught either concurrently or as inte-

grated training. This adds realism to the training, allows instructors to work with small groups, conserves training time, and makes better use of training facilities. Succeeding chapters in this manual suggest various methods of integrating basic squad tactics into technique of fire training. (FM 7-15 contains the tactical doctrine concerning the employment of the rifle squad.) Chapter 5 amplifies this doctrine where necessary and shows the tactical application of technique of fire in order to assist the instructor in the integration of these subjects.

## CHAPTER 2

### FUNDAMENTALS OF TECHNIQUE OF FIRE (DAY)

---

#### Section I. INTRODUCTION

##### 4. General

Each rifle squad member must be trained in standard methods of applying his fire as part of a team, and must perform his assigned task automatically and effectively. The rifle squad must be trained to act as an effective team in the application and control of its collective fire. This training is called "Technique of Fire of the Rifle Squad."

##### 5. Phases of Instruction

Instruction in daytime technique of fire is progressive and is divided into two phases. Dur-

ing the first phase, instruction is presented in the fundamentals of range determination, characteristics of rifle, automatic rifle and grenade launcher fire, application of fire, and fire control. The second phase of instruction is field and landscape target firing which is discussed in detail in chapter 3. During this phase, the fundamentals are applied. Training in the fundamentals (phase one) need not be presented in any set sequence. For example, instruction in fire control may precede instruction in application of fire, or all of the fundamentals may be presented at the same time through the use of concurrent training stations.

#### Section II. RANGE DETERMINATION

##### 6. General

Range determination is the process of finding the distance between the firer's position and his target. All squad members must know how to determine the distance from their position to the enemy so—

- a. Targets can be designated or located.
- b. The riflemen can adjust their point of aim when using the battlesight setting.
- c. The grenadiers can place the proper sight setting on their weapons.

##### 7. Methods of Determining Range

Range can be determined by such means as measuring on maps or with range finders; but in combat, the methods most frequently used by the squad members are the 100-meter unit of measure and the appearance of objects. To become fully proficient, they must practice both of these methods on varied terrain and under various conditions of light and weather so they can learn how these conditions affect their estimates.

##### 8. The 100-Meter Unit of Measure Method

a. To use this method, the soldier must be able to visualize a 100-meter distance on the ground. With this unit in mind, he can mentally determine how many of these 100-meter units there are between his position and the target. In training, estimates should be checked by pacing off the distance (the average man takes about 130 steps per 100 meters). Constant practice in applying the 100-meter unit of measure is essential. This method is used for ranges up to 500 meters (fig. 1).

b. For ranges from 500 to 1,000 meters, the soldier selects a point halfway to the target, determines the range to the halfway point by applying the 100-meter unit of measure, then doubles the estimate (fig. 2). This method of determining range is not accurate beyond 1,000 meters.

c. Certain types of terrain will affect the appearance of 100-meter units of measure. On terrain that slopes upward toward the target, 100 meters appear longer than on level terrain;

on ground that slopes downward toward the target, 100 meters appear shorter than on level terrain.

### 9. The Appearance of Objects Method

a. Many times it is impossible to observe all of the terrain to the target. In this case, it is impractical to apply the 100-meter unit of measure, and ranges must be determined by the appearance of objects method. To use this method, the soldier must learn through practice how familiar objects look at various known ranges. For example, he studies the appearance of a man when he is standing 100 meters away. He fixes his appearance firmly in mind—his size and the details of his uniform and equipment. Next, he studies the man in the kneeling position, then in the prone position. This same procedure is followed at various known ranges out to 500 meters. By comparing the appearance of the man in these positions at known ranges, he can establish a series of mental images which will help him to determine range on unfamiliar terrain out to 500 meters.

b. Training should be conducted to familiarize the rifleman with the appearance of other familiar objects such as weapons and vehicles.

c. Certain factors affect the appearance of objects and an understanding of them will help to make estimates more accurate. See table I.

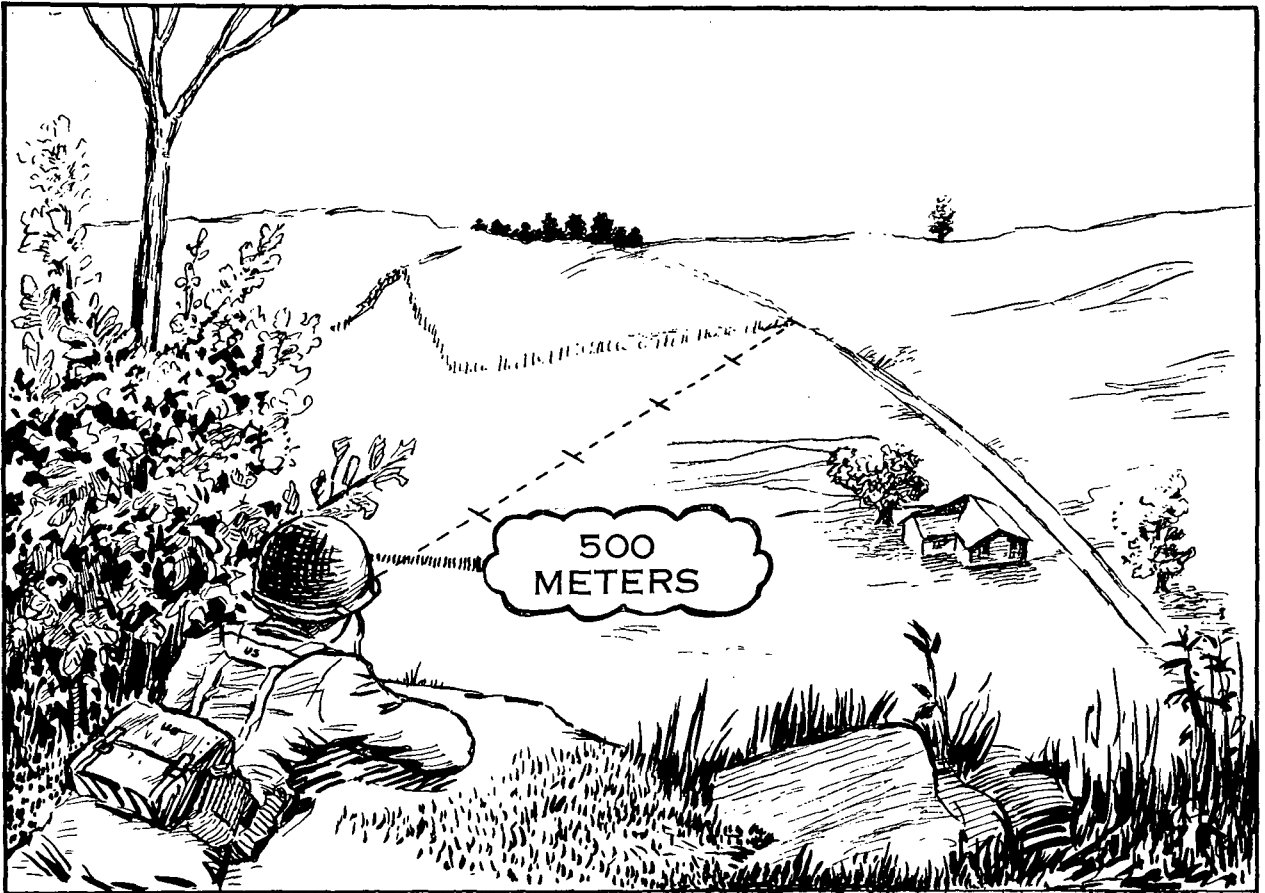
### 10. Lateral Distance Measurement

a. In addition to being able to determine range accurately, the soldier needs a quick method of measuring lateral distances right or left from a reference point to a target or for measuring the width of a linear target. This is difficult to do in meters or any unit of measure without special instruments or mathematics. Because such measurements are difficult and special instruments are not available to the squad, the squad members do not attempt to determine lateral distance in meters. Instead, the fingers are used to express lateral measurements. This is not a method of range determination, but only a method of measuring the lateral distance in fingers between two points.

b. To measure the distance in fingers between a reference point and a target, extend the arm with the palm outward and the elbow locked. Close one eye and sight along the edge of the first finger, placing the edge of the finger along the flank of the target or reference point. Note

Table 1. Factors Affecting the Appearance of Objects

Factors to be considered in estimating range by eye	Objects appear nearer than they really are and ranges are underestimated	Objects appear more distant than they really are and ranges are overestimated
The target—its clearness of outline and details.	When most of the target is visible and offers a clear outline.	When only a small part of the target may be seen or is small in relation to its surroundings.
Nature of terrain or position of the observer.	When looking across a depression, most of which is hidden from view. When looking downward from high ground. When looking down a straight open road or along a railroad track. When looking over uniform surfaces like water, snow, desert, or grain fields.	When looking across a depression, all of which is visible. When looking from low ground toward high ground. When vision is narrowly confined as in streets, draws, or forest trails.
Light and atmosphere-----	In bright light or when the sun is shining from behind the observer. When the target is in sharp contrast with the background or is silhouetted, by reason of size, shape, or color. When seen in the clear atmosphere of high altitudes.	In poor light such as dawn and dusk, in rain, snow, fog, or when the sun is in the observer's eyes. When the target blends into the background or terrain.



*Figure 1. Applying the 100-meter unit of measure for ranges up to 500 meters.*

the space remaining between the two points and then fill this space by raising fingers until the space is covered (fig. 3). The measurement from the reference point to the target is then

stated as being one or more fingers, depending on how many fingers are raised to cover this distance. It should be emphasized that fingers cannot be calibrated to any unit of measure.

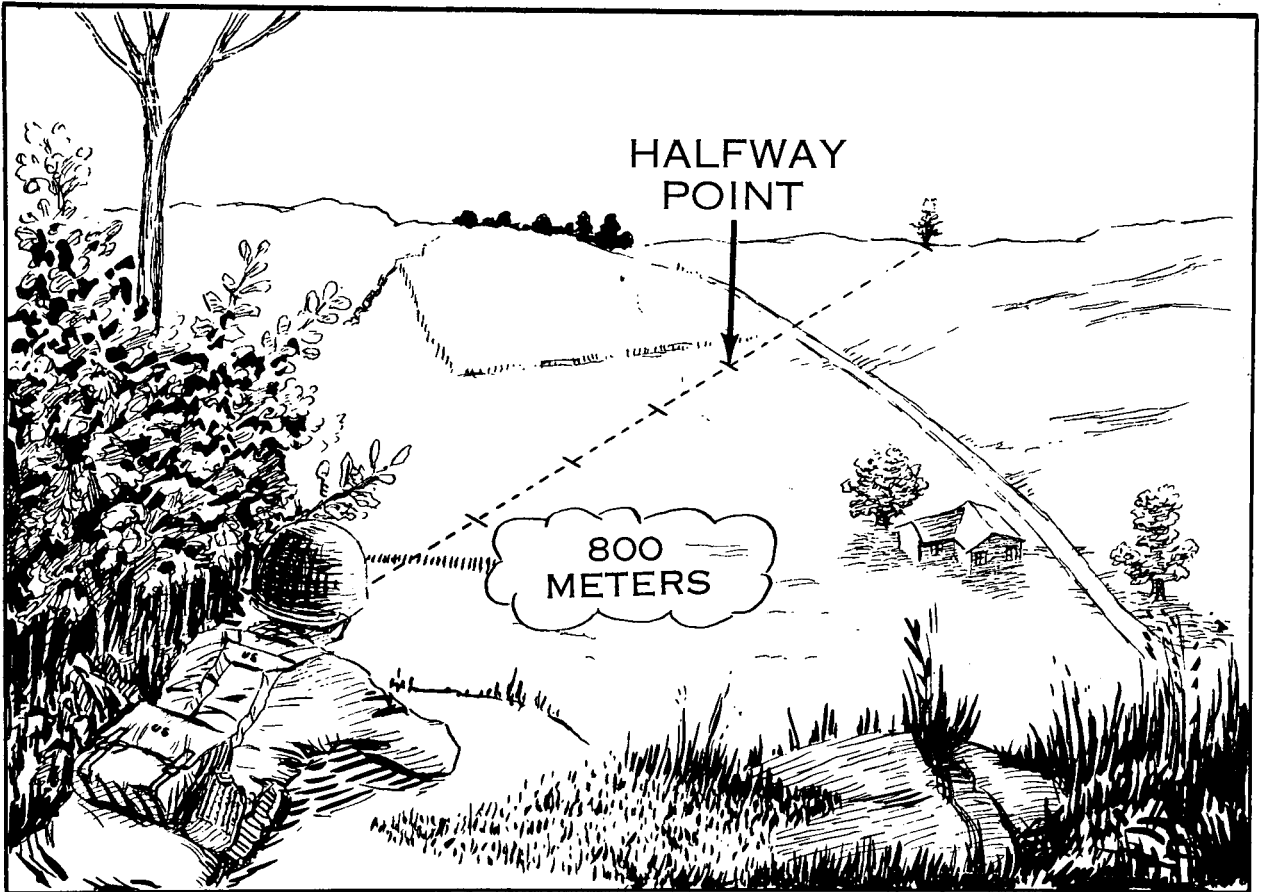


Figure 2. Applying the 100-meter unit of measure method for ranges greater than 500 meters.

### Section III. CHARACTERISTICS OF RIFLE, AUTOMATIC RIFLE, AND GRENADE LAUNCHER FIRE

#### 11. General

The squad members must have a knowledge of the characteristics of fire of the weapons in order to apply their fires to the best possible advantage.

#### 12. Trajectory, Danger Space, Cone of Fire, Beaten Zone, and Casualty Radius

*a. Trajectory.* This is the path of the projectile in its flight from the muzzle of the weapon to the point of impact.

- (1) *Rifle and automatic rifle.* At ranges out to 300 meters, the trajectory of rifle and automatic rifle fire is almost flat. At greater ranges, it is necessary for the firer to add elevation to his weapon, thus raising the height of the trajectory (fig. 4).

- (2) *Grenade launcher.* The grenade launcher is characterized by a high angle of fire or high trajectory. The trajectory of grenade launcher fire is quite different from that of the rifle or automatic rifle. The muzzle velocity of the grenade launcher is relatively slow when compared to that of the rifle. However, this muzzle velocity is sufficient to permit flat trajectory fire out to 150 meters. When engaging targets within this range, the weapon is aimed in a manner similar to the rifle. When engaging targets at greater ranges, the angle of elevation must be increased. At the maximum effective range of the launcher (350 meters), the muzzle of the weapon is approximately  $20^{\circ}$  above the hori-



Figure 3. The finger measurement method.

(H = MAXIMUM ORDINATE—HIGHEST POINT OF TRAJECTORY)

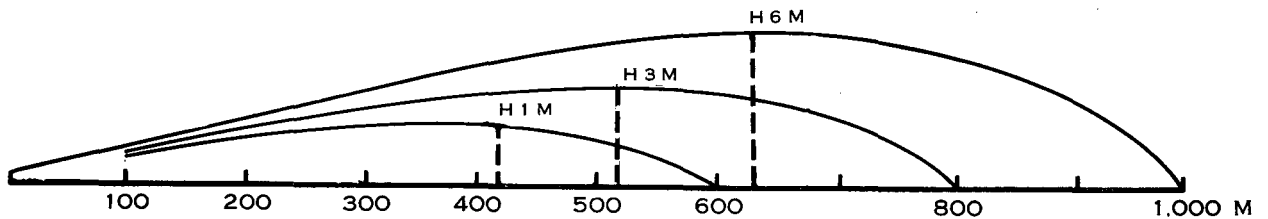
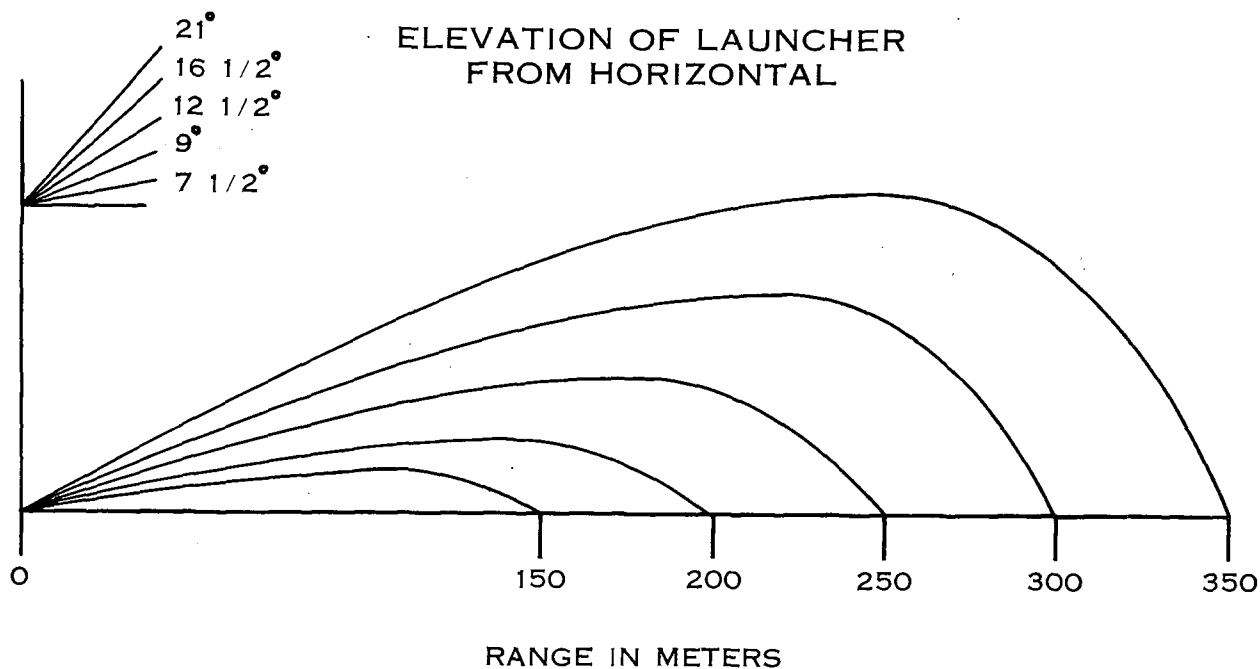


Figure 4. Trajectory of 7.62-mm ammunition showing maximum ordinate (H) of trajectory.



## TRAJECTORY — M79 GRENADE LAUNCHER



*Figure 5. Trajectory of 40-mm grenade launcher ammunition.*

zontal. This results in a relatively high trajectory and increases the time of flight of the projectile to the target (fig. 5). Since the trajectory is high and the time of flight long at ranges beyond 150 meters, wind will have considerable effect upon the projectile, and the grenadier must allow for this.

*b. Danger Space.* This is the space between the firer and the target where the trajectory does not rise above the height of an average standing man, and the area around the beaten zone (*d* below).

(1) A high velocity bullet fired from the prone position over level or uniformly sloping terrain at a target less than 700 meters away will not rise above the height of an average man (fig. 6). Anyone standing along this line of fire would be hit by the bullet. Therefore, this entire distance is danger space.

(2) When firing at targets at ranges greater than 700 meters, the trajectory will rise above the height of an average standing man. Therefore, not all the distance between firer and target is danger space (fig. 6).

*c. Cone of Fire.* Successive projectiles fired from the same weapon at the same target take a slightly different path through the air. These differences are caused by small variations in the individual's aiming and holding the weapon, ammunition, and atmospheric conditions. The pattern formed by these multiple projectiles in their flight through the air is called the cone of fire (fig. 7).

*d. Beaten Zone.* The area where the cone of fire strikes the ground or target is called the beaten zone. On uniformly sloping or level terrain, the beaten zone is elliptical (long and narrow) in shape. If the ground slopes down-

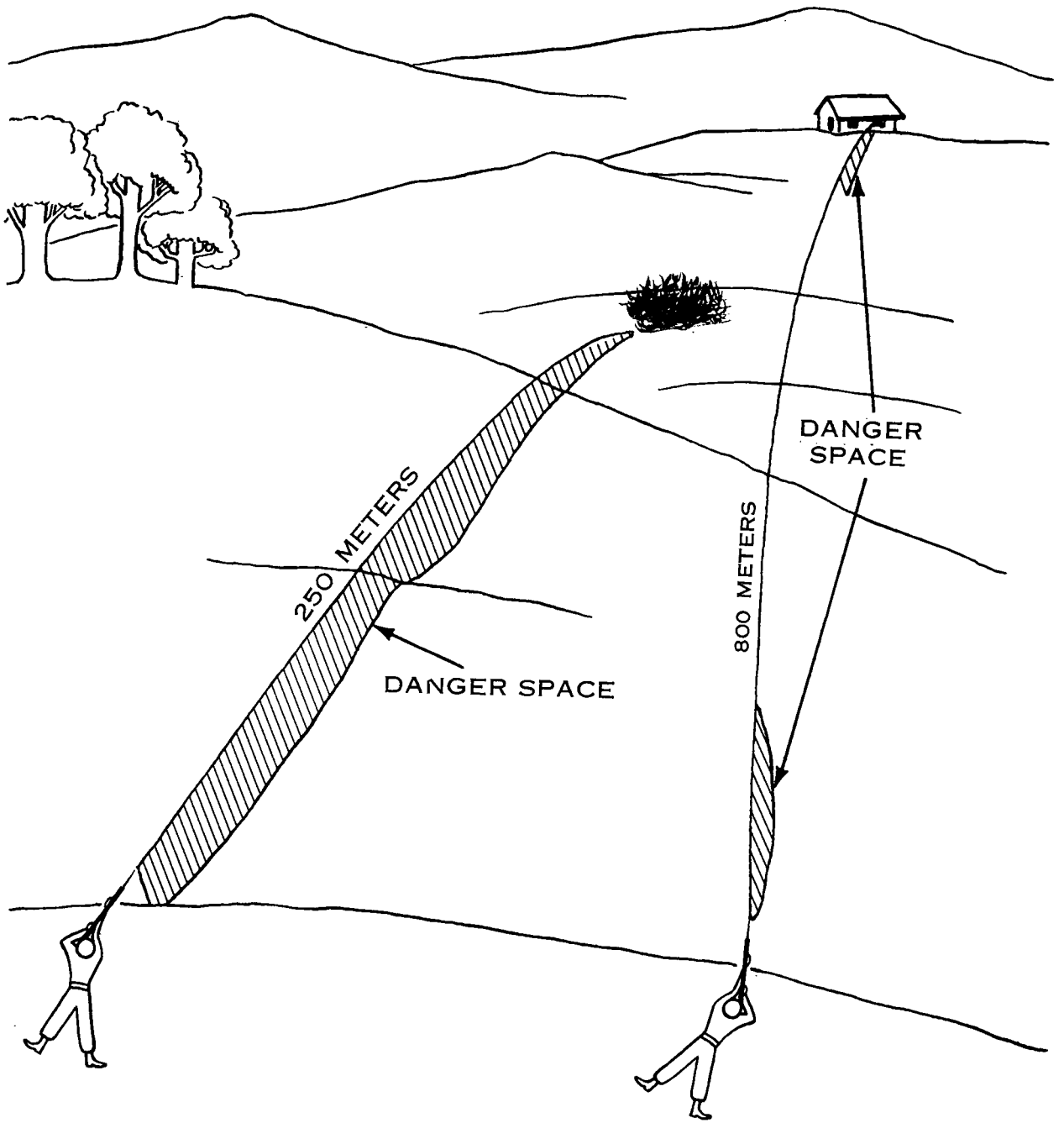


Figure 6. Danger space.

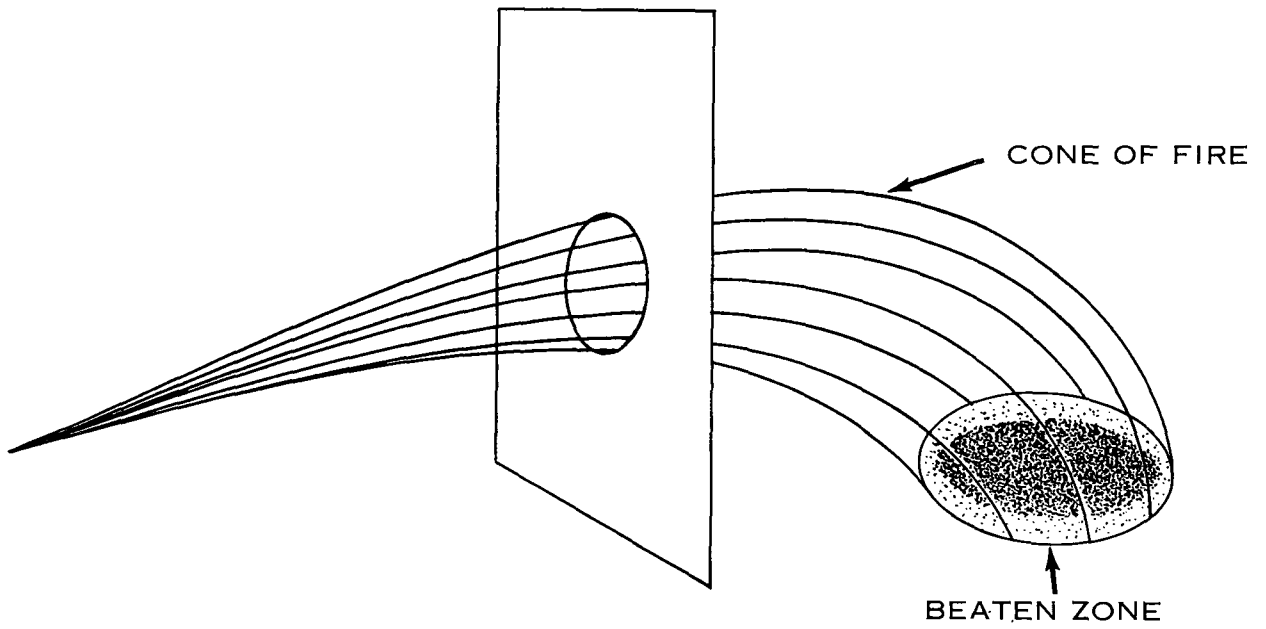


Figure 7. Cone of fire.

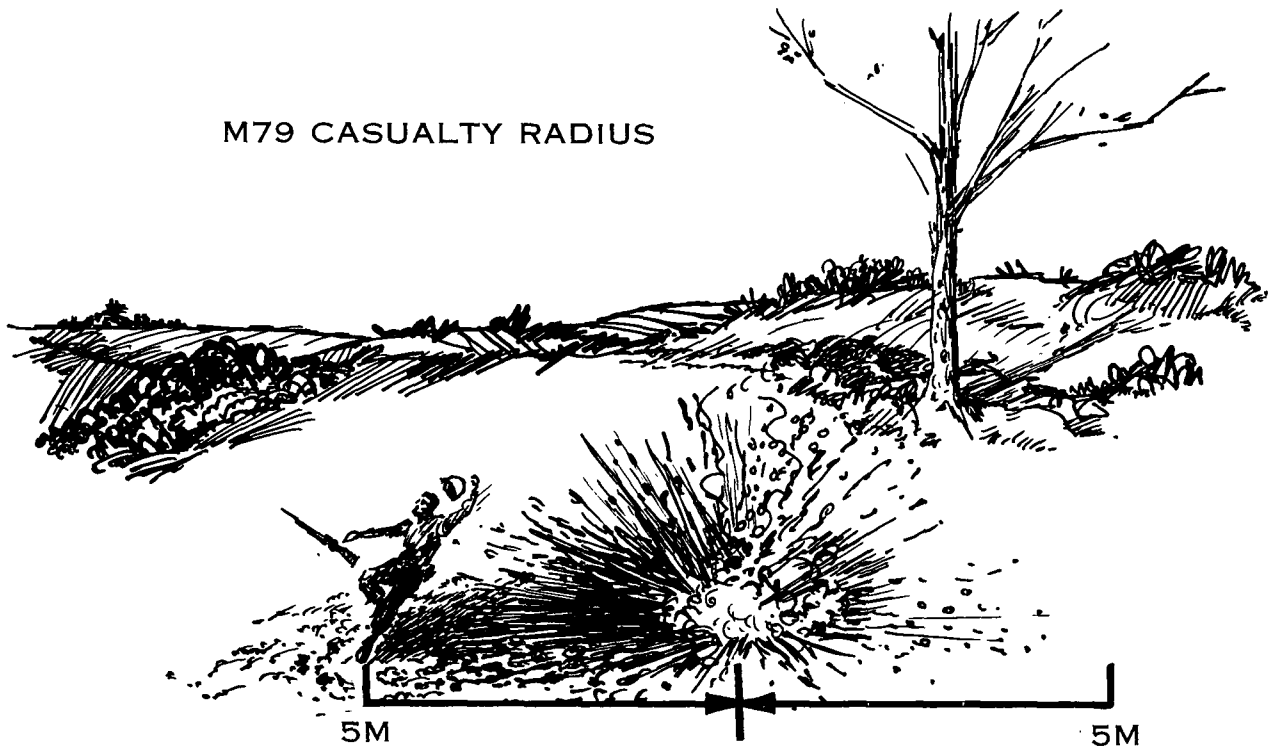


Figure 8. Casualty radius of 40-mm high explosive grenade.

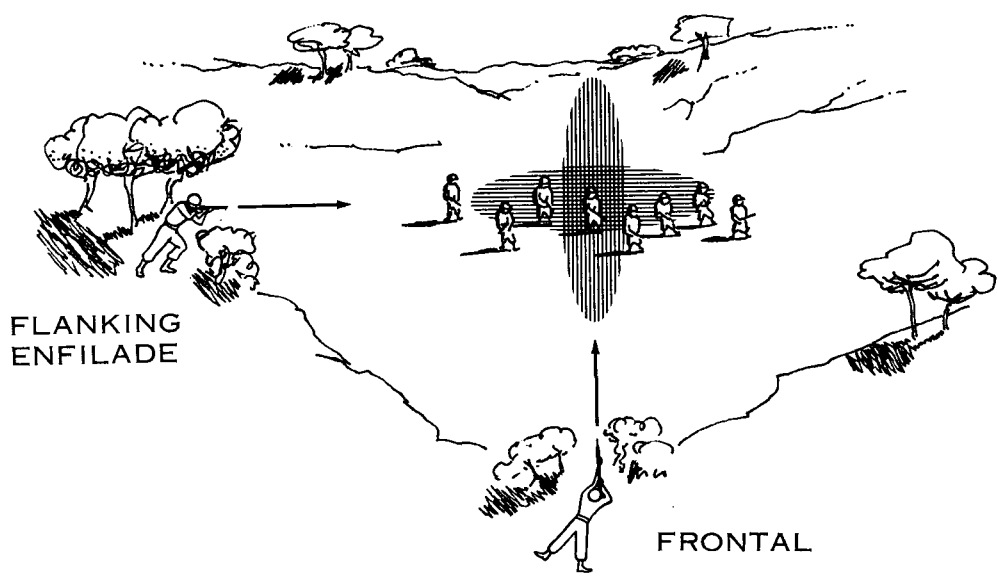
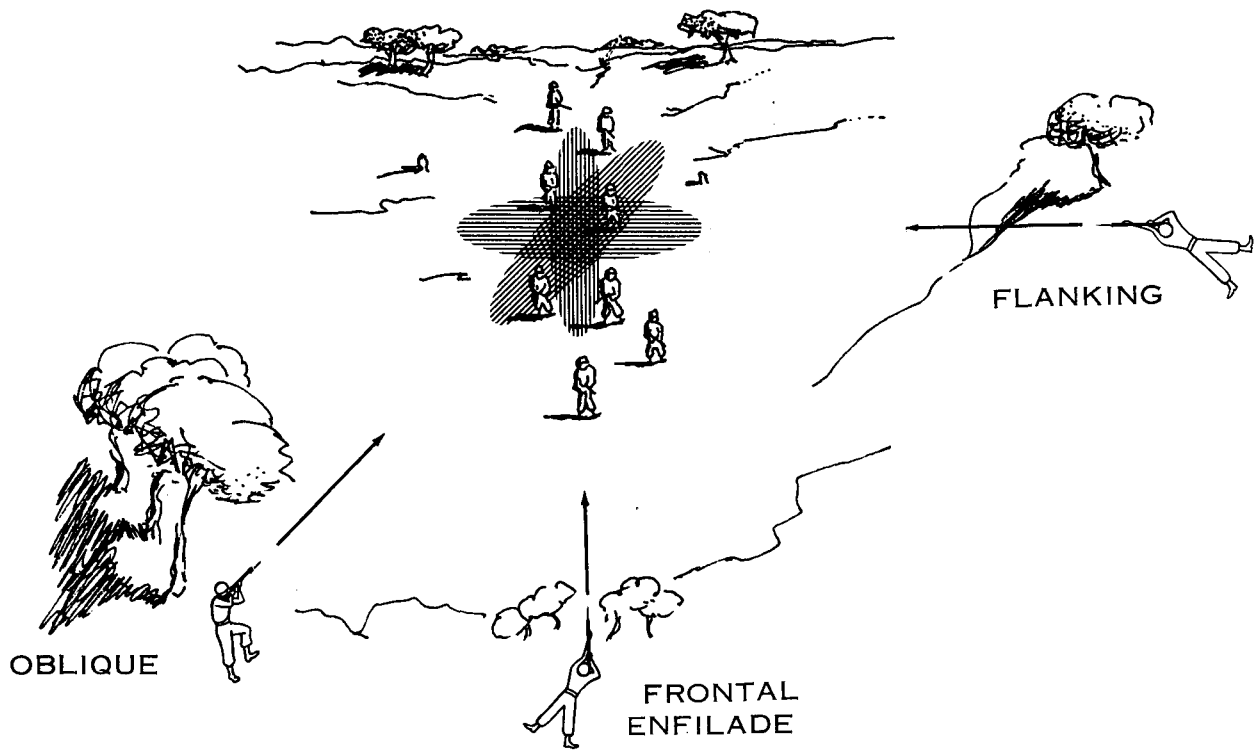


Figure 9. Classes of fire with respect to the target. Shaded area on target represents the beaten zone.

ward, the beaten zone will become longer. When fires are delivered into rising ground the beaten zone will be shorter. As the range to the target increases, the beaten zone will become longer and wider (figs. 7 and 10). An understanding of the beaten zone helps the squad members to get the best effect from their fires.

*e. Casualty Radius.* When high explosive projectiles are fired, they produce casualties by fragmentation and concussion. The area around the point of impact of the projectile where personnel would be killed or injured is called the casualty radius. The 40-mm high explosive projectile fired by the grenade launcher has an effective casualty radius of five meters (fig. 8).

### 13. Classes of Fire

Rifle and automatic rifle fire is classified with respect to the ground and the target.

*a.* Fire with respect to the target (fig. 9) is—

- (1) *Frontal* when delivered at a right angle to the front of the target.
- (2) *Flanking* when delivered into the flank of the target.
- (3) *Oblique* when the long axis of the beaten zone is at an oblique to the long axis of the target.

- (4) *Enfilade* when the long axis of the beaten zone coincides with the long axis of the target. This type of fire is either frontal or flanking and is the most desirable type of fire with respect to the target because it makes maximum use of the beaten zone.

*b.* Fire with respect to the ground (fig. 10) is—

- (1) *Grazing* when the height of the trajectory does not rise above the height of an average standing man. Over uniformly sloping or level terrain, grazing fire can be obtained to a range of 700 meters with the rifles and automatic rifles. As the height of the trajectory increases or as the terrain varies, the amount of grazing fire will decrease.
- (2) *Plunging* when the angle of fall of the bullets with respect to the slope of the ground is such that the danger space is practically confined to the point of impact (beaten zone). Plunging fire is obtained when firing at long ranges, when firing from high ground to low ground, and when firing into abruptly rising ground.

## Section IV. APPLICATION OF FIRE

### 14. General

*a.* Application of fire consists of the methods the squad uses to insure complete and effective coverage of a designated target to include suspected areas in which the enemy might be located.

*b.* Training in the methods of applying squad fires can be accomplished only after the individual squad members have learned to recognize the various types of targets they might encounter in combat.

### 15. Types of Targets

Targets presented to the rifle squad during combat, with few exceptions, will consist of enemy personnel in various formations or prepared positions. All such targets have width and depth and the fires applied to these targets by the squad are designed to thoroughly cover

the area in which the enemy is known or suspected to be.

*a. Linear targets* have more width than depth. Figure 11 shows a line of enemy riflemen, a typical linear target.

*b. Column targets* have more depth than width. Figure 12 shows an approaching enemy column of troops, a typical column target.

*c. Point targets* are targets which require the use of a single aiming point and are confined to a small area. Enemy bunkers, weapons emplacements, observation posts, vehicles, and small groups of personnel are considered point targets.

*d. Area targets*, as discussed in this manual, are almost equal in width and depth. This type target exists when the enemy is in a certain area, but his exact location is not known.

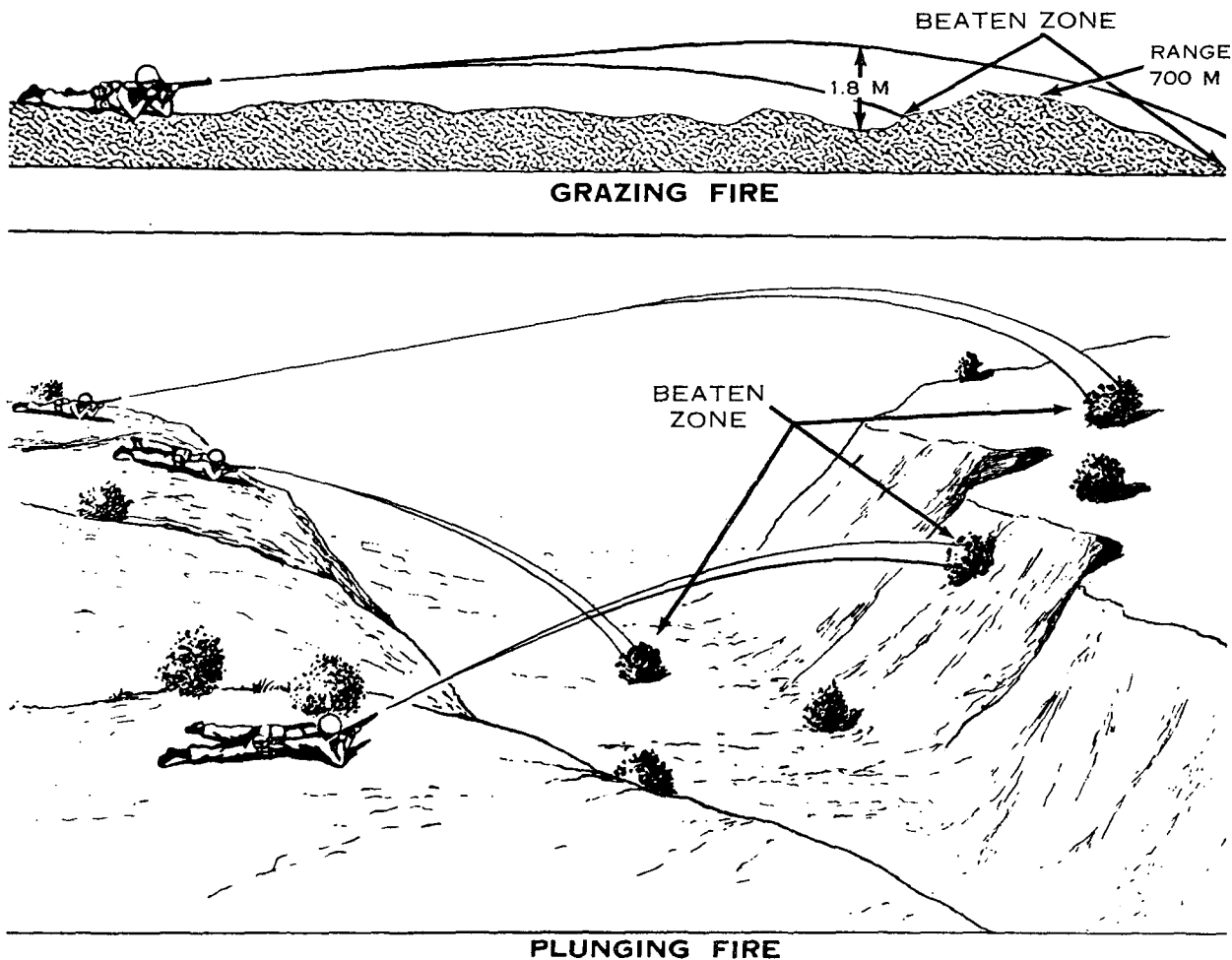


Figure 10. Classes of fire with respect to the ground.

## 16. Distribution, Concentration, and Rate of Fire

In combat, the size and nature of a target may call for the firepower of the entire squad or only part of it. The individual squad members engage various types of targets by applying their fires in a prescribed and controlled manner.

### a. Distribution and Concentration of Fire.

- (1) *Distributed fire* is fire delivered in width and depth so a linear, column, or area target is effectively covered.
- (2) *Concentrated fire* is fire directed at a point target such as an automatic weapon. Concentrated fire may be delivered by the entire squad or by only part of it.

b. *Rate of Fire.* The maximum effective rate at which a squad member can fire is determined by how fast he can take a sight picture, properly control the trigger, and reload his weapon. The sustained rate of fire is that rate which can be maintained indefinitely without danger to the firer or damage to the weapon. The squad members fire their first few rounds, particularly in the case of surprise fire, at the maximum effective rate in order to gain fire superiority. Thereafter, the rate is reduced to the point that will maintain fire superiority. This reduction is necessary to insure continued operation of the weapons and conserve ammunition.

## 17. Application of Fire on a Linear Target

The squad leader designates the center and the flanks of a linear target unless the target is



Figure 11. Linear target.

obvious to the squad. The normal deployment from the squad's combat formations places the ALFA team on the right and the BRAVO team on the left. Each fire team normally covers half of the squad target unless the terrain or other factors dictate that one team cover a larger portion.

*a. Riflemen.* The riflemen fire initially on that portion of the target corresponding to their position in the squad (fig. 13). The left flank rifleman fires initially on the left flank portion of the squad target, overlapping the known flank of the target and the fires of the rifleman on his right. The center rifleman fires on the center portion of the squad target, overlapping his fires with the fires of the riflemen on his left and right. The right flank rifleman fires on the right portion of the squad target, overlapping with the rifleman on his left and overlapping the known flank of the target. The riflemen fire at known or suspected enemy in their portion of the target. After all known enemy personnel in their portion of the target

are eliminated, they fire at known or suspected enemy anywhere within their team target.

*b. Automatic Riflemen.* The automatic riflemen begin firing on the center of the squad target, insuring that their fires overlap (fig. 14). When the range to the target is 460 meters or less, they fire in short, accurate bursts (two or three rounds), distributing their fire from the center across their respective team targets to just outside the known flanks. They then return their fires to the center in the same manner. When the target is beyond 460 meters, the automatic riflemen use the same technique firing semiautomatically. After fire superiority has been gained, the automatic riflemen fire at known or suspected enemy anywhere within their team target, or other targets as directed.

*c. Grenadiers.* The grenadiers begin firing just outside the known flank of their respective team target (fig. 14). Firing as rapidly as possible, they distribute their fire across the team target, overlapping their fire at the center of the squad target. They then return to the flanks



Figure 12. Column target.

in the same manner. After fire superiority has been gained, the grenadiers fire at known enemy within their team target as directed.

*d. Team Leaders.* The team leaders distribute their fire on the team target where they feel it will be the most effective (fig. 14). The team leaders make frequent checks with the squad leader for signals and instructions. They are also responsible for adjusting their teams' fire or shifting it, if necessary, to any portion of the squad target.

### 18. Application of Fire on a Column Target

Unless the target is obvious, the squad leader designates its center, front, and rear. The team leader and riflemen of one fire team cover the front half and the team leader and riflemen of the other team cover the rear half. In some

situations, this procedure may have to be changed because of the terrain, location of the target, or the disposition of the squad. In most situations, the BRAVO team fires on the front half of the target and the ALFA team fires on the rear half of the target (fig. 15). When this procedure is used, the following techniques are applied by the squad members:

*a. Riflemen.* The right flank rifleman in the BRAVO team fires on the front portion of the target, and the left flank rifleman of the BRAVO team fires at the center of the target. The rifleman of the ALFA team fires on the rear portion of the target. Each rifleman is responsible for covering approximately one-third of the target. The riflemen fire rapidly, distributing their fire in depth along their portion of the target. If the enemy column changes



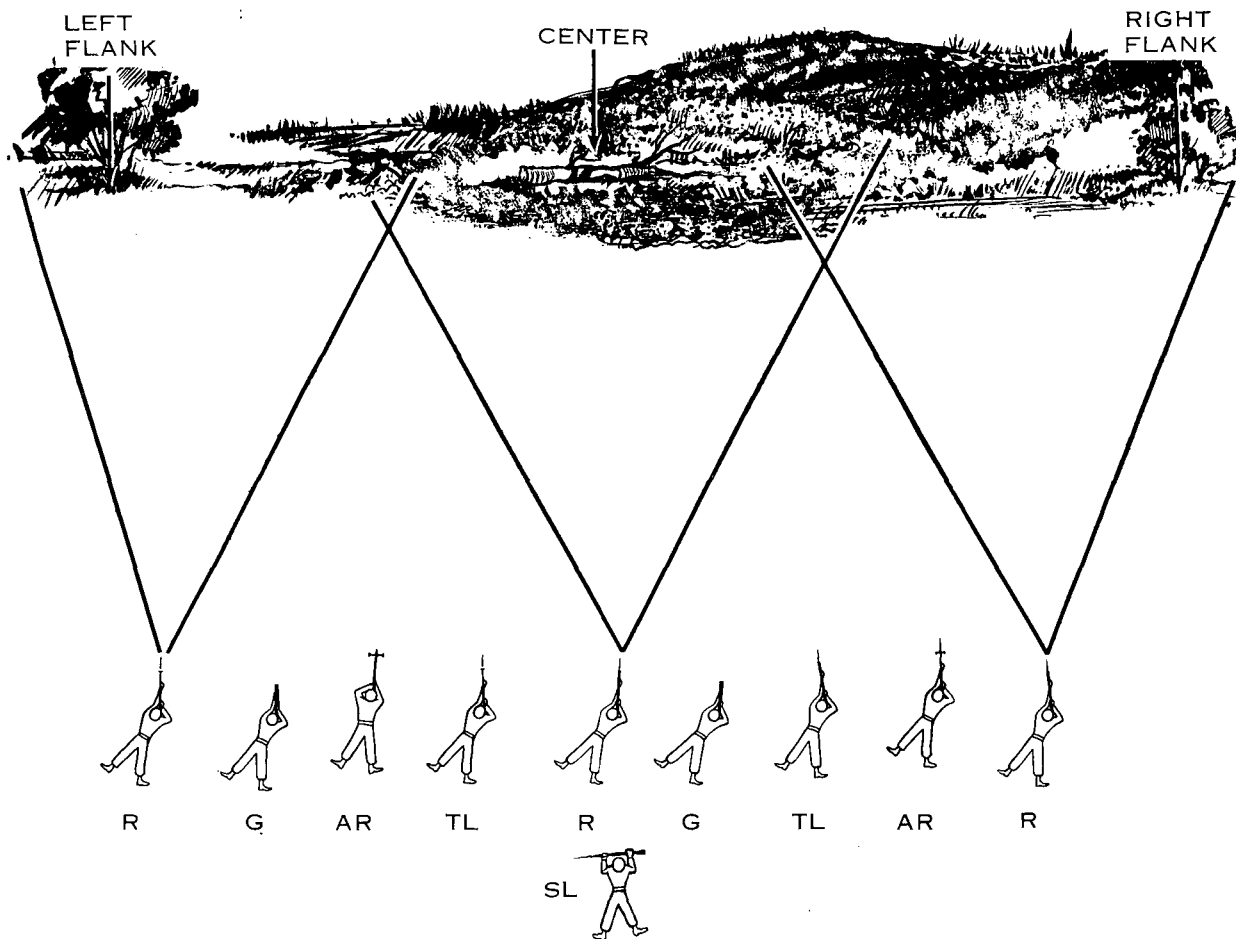


Figure 13. Application of fire by riflemen on a linear target.

formation or disperses, the riflemen distribute their fires as directed.

*b. Automatic Riflemen.* The automatic riflemen fire in three- to five-round bursts at the center of the target. They do not distribute their fire since the beaten zone of the automatic rifles will adequately cover the target. If the enemy column changes formation or disperses, the automatic riflemen distribute their fire as directed.

*c. Grenadiers.* The grenadiers fire initially on the center of a column target. This insures that, even with a slight error in range estimation, their first rounds will hit the target. If the enemy column changes formation, subsequent rounds are distributed in the target area as directed.

*d. Team Leaders.* The team leaders distribute their fires in depth throughout their team targets, where their fires will be most effective. Team leaders must be alert to control and shift the fires of their teams if the enemy disperses or moves into another formation.

## 19. Application of Fire on a Point Target

Point targets may be engaged by all or any combination of weapons in the squad at the discretion of the squad leader.

*a. Team Leaders and Riflemen.* The team leaders and riflemen engage all types of point targets as directed by the squad leader.

*b. Automatic Riflemen.* The automatic riflemen fire semiautomatically when engaging point targets such as windows, bunker aper-

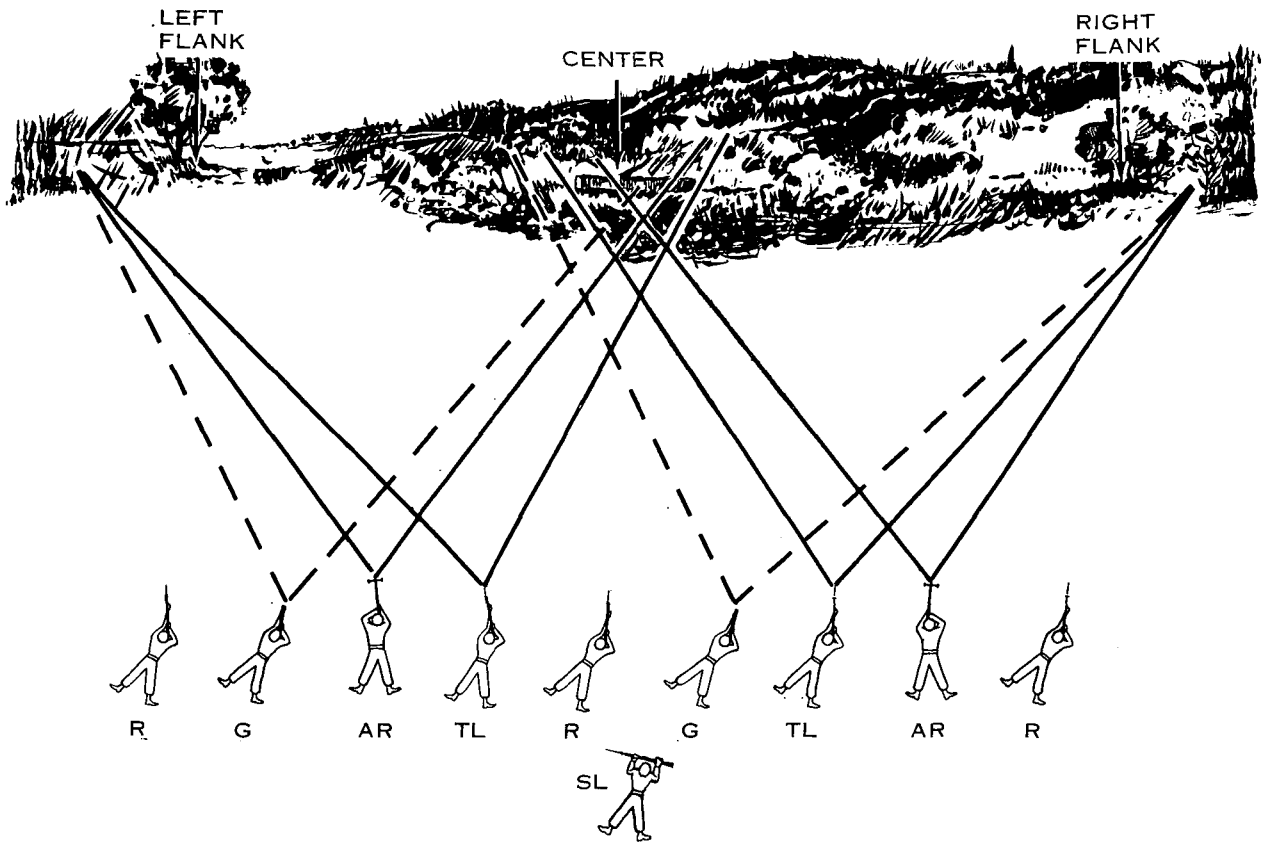


Figure 14. Application of fire by the automatic riflemen, grenadiers, and team leaders on a linear target.

tures, or other targets that require pinpoint accuracy. When firing at larger point targets such as crew-served weapons or small groups of personnel, automatic fire is used in order to take advantage of the larger beaten zone. The automatic riflemen fire simultaneously when a heavy volume of fire is needed to destroy a point target. When a heavy volume of fire is not needed or when it is necessary to engage a target for long periods, the automatic riflemen alternate their fire. Alternating fire allows adjustment of fire, continuous delivery of fire on the target, and insures continued operation of the automatic rifles. When engaging any type of point target beyond 460 meters, semiautomatic fire is used.

c. *Grenadiers.* The grenadiers fire at all types of point targets out to 150 meters. From 150 to 350 meters, grenadiers can effectively engage only those targets that can be destroyed

or neutralized with area fire, i.e., open weapon positions or small groups of personnel.

## 20. Application of Fire on a Selected Area (Area Fire)

The squad leader designates an area target by indicating to the squad the width and depth of the target. Each fire team is responsible for half of the target area.

a. *Riflemen.* Each rifleman distributes his fire in both width and depth, firing at suspected enemy locations within his portion of the squad target.

b. *Automatic Riflemen.* The automatic riflemen distribute their fire in width and depth within their team targets with priority to enemy automatic weapons which may appear. Automatic fire is used when delivering area fire at any range.

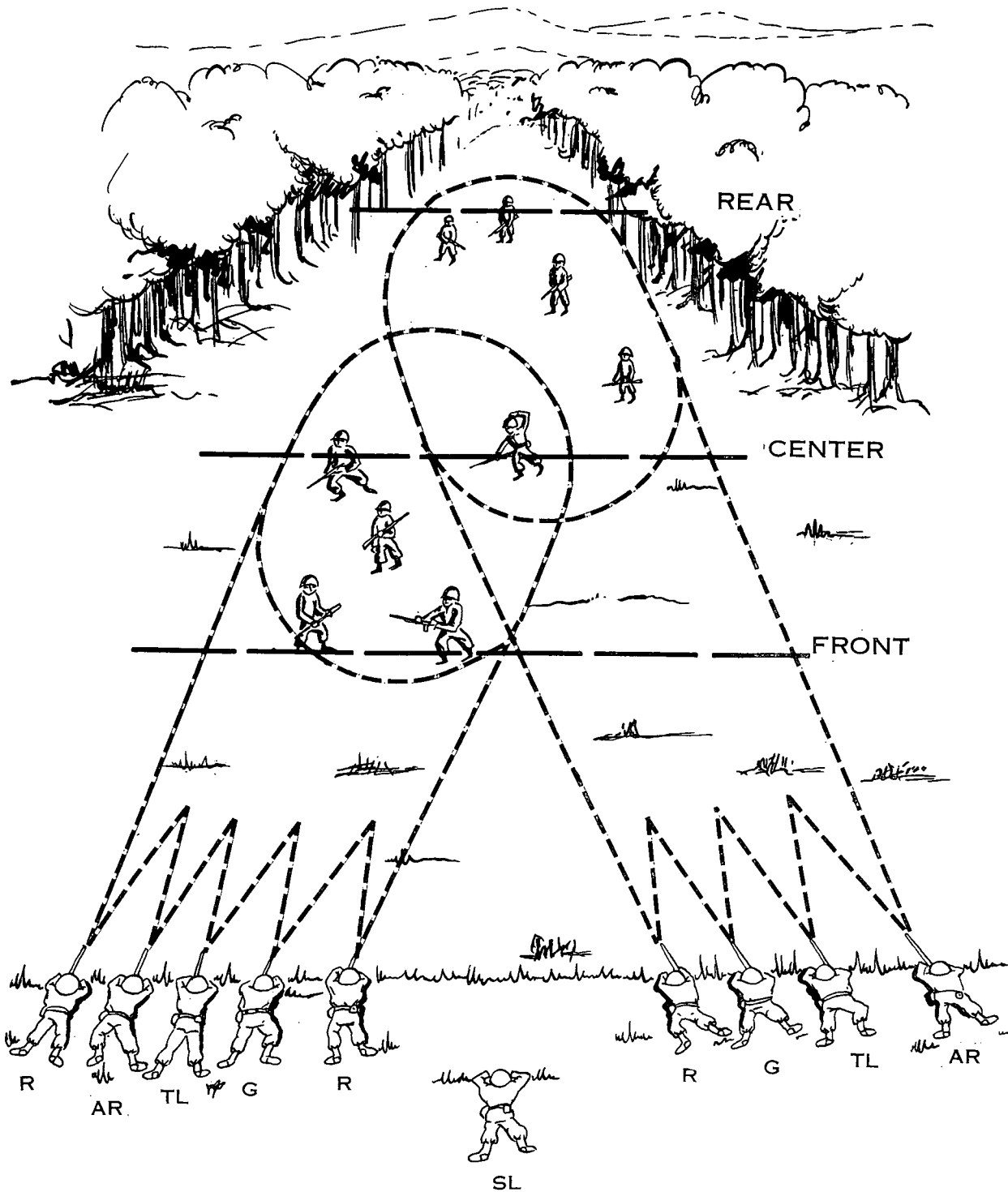


Figure 15. Squad application of fire on a column target.

*c. Grenadiers.* The grenadiers distribute their fires in both width and depth at suspected enemy locations within their team targets. Fires are delivered rapidly, and shifted to completely cover the area.

*d. Team Leaders.* The team leaders fire anywhere within their team target where fires will be the most effective.

## 21. Automatic Rifle Capabilities

The capability of delivering either effective automatic or semiautomatic fire allows for flexible employment of this weapon. The stable bipod mount permits the automatic riflemen to deliver a heavy volume of accurate, semiautomatic fire out to 700 meters, which is beyond the maximum effective range of other squad weapons. The automatic riflemen should be employed to take full advantage of this capability.

## 22. Assault Fire (Day)

Assault fire is delivered by the rifle squad during the final phase of an attack. The fire is distributed in the same manner as on a linear type target, except that the target area (objective) is not divided into team areas. During the assault, squad members fire as rapidly as possible consistent with their ability to place effective fire on the objective.

*a. Team Leaders and Riflemen.* The team leaders and riflemen fire well-directed shots from either the shoulder or underarm firing position. They fire at known or suspected enemy locations on that portion of the objective which corresponds with their position in the assault formation.

*b. Automatic Riflemen.* The automatic riflemen fire in short bursts from the underarm firing position at known or suspected enemy locations with priority to enemy automatic weapons. Fires of the automatic riflemen are distributed over as much of the objective as possible.

*c. Grenadiers.* The grenadiers fire well-directed shots using the pointing technique (fig. 31), or they fire well-aimed shots at point targets that appear on the objective. The grenadiers fire as rapidly as possible and distribute their fires over that half of the objective corresponding to their position in the assault formation. When the grenadiers cannot place effective fire on the objective without endangering friendly troops, they fire on retreating enemy or other targets of opportunity. When there are no appropriate targets for the grenade launcher, the grenadiers use their pistols for personal protection until they reach a position where they can fire the grenade launcher.

## Section V. FIRE CONTROL

### 23. General

To be effective against the enemy, the squad's fire must be correctly applied and controlled. Fire control depends on the ability of the squad leader to move his men from one firing position to another and have them open fire, shift fire, and cease fire. In order to do this, he must be able to put into practice all of the methods of fire control and develop teamwork within the squad.

### 24. Methods of Fire Control

There are several methods of controlling squad fires. The noise and confusion of battle will limit the use of some of these methods. Therefore, the squad leader must select the method or combination of methods to best accomplish his purpose.

*a. Oral.* This is an effective method of control; but, at times, the squad leader will be too far away from the squad members or the noise of battle will make it impossible for the squad members to hear him.

*b. Arm-and-Hand Signals.* This is an effective method when the squad members can see the leader. All squad members should understand the standard arm-and-hand signals covered in chapter 5.

*c. Prearranged Signals.* These are either visual or sound signals, such as pyrotechnics or blasts on a whistle. These signals should be included in appropriate squad SOP's and must be clearly understood by all squad members.

*d. Passing Orders from Man to Man.* Simple orders may be passed from man to man successfully. This method should not be used for com-

plicated orders because they can be very easily misunderstood, or may require too much time when speed is important.

*e. Personal Contact.* In many situations, the squad leader must move to individual squad members to issue orders. This aggressive method of control is used more than any other by small unit leaders. The squad leader must use maximum cover and concealment to keep from disclosing the squad's position. He must not spend too much time with one person and thereby lose control of the rest of the squad.

*f. Use of the Team Leaders.* The squad leader must use the team leaders to assist him in the job of fire control. He assigns the team leaders specific responsibilities prior to combat and issues additional instructions to them as required.

*g. Standing Operating Procedures.* Standing operating procedures are actions the squad performs automatically without command. SOP's are developed during the training of the squad. Their application eliminates many commands and simplifies the squad leader's job of control. For example, actions the squad takes when subjected to surprise fire and actions of individuals during a fire fight can be covered by SOP's. The following are examples of SOP's that can be developed:

(1) *The search-fire-check SOP.*

- (a) *Search.* The squad members search their assigned portions of the squad sector.
- (b) *Fire.* Squad members open fire automatically on targets appropriate to their weapons that appear in their area of responsibility. When a squad target appears, each man engages it as explained in paragraph 17.
- (c) *Check.* While firing, team members must frequently glance at their team leaders for instructions; the team leaders also check frequently with the squad leader. At this time, instructions can be passed to the members of the squad by arm-and-hand signals or other methods of control.

(2) *The return fire SOP.* The rifle squad is trained to return enemy fire without order.

(3) *Shifting fires SOP.* SOP's can be used to aid the squad leader in controlling the fires of the squad when presented with several types of targets at the same time. The following examples are SOP's that can be used to get the fires of certain individuals shifted from one target to another in a minimum amount of time:

- (a) *Riflemen.* The riflemen are always responsible for any targets that appear in their portion of the squad sector. If a rifleman is firing on a squad target and at the same time detects a target located in his portion of the squad sector, he should shift his fires without order and engage this target.
- (b) *Automatic riflemen.* The automatic riflemen are responsible for engaging enemy automatic weapons anywhere within the squad sector. When such a target appears, the automatic riflemen shift their fires without order to engage it.

(4) *Rate of fire SOP.* When the squad engages a target, the various squad members will fire the following amounts of ammunition at the maximum effective rate (par. 16): team leaders and riflemen—20 rounds, automatic riflemen—40 rounds, grenadiers—five rounds. Thereafter, squad members will decrease their rates of fire to the point that will maintain fire superiority.

## 25. The Squad Fire Command

*a.* When the squad leader decides to initiate fire on a target which is not obvious to all squad members, he must give them the information they will need to place effective fire on the target. He must get their attention, tell them what the target is, where it is located, how much ammunition to fire, and give the command to open fire. A fire command is given in order to do this quickly and without confusion.

*b.* The noise and confusion of combat, the terrain, and the disposition of the squad make the use of complete fire commands, particularly oral commands, difficult and impractical. There-

fore, informal and abbreviated fire commands are more appropriate. However, before the squad members can react properly when they receive informal or abbreviated fire commands, they must understand all elements of the fire command and the sequence in which they are given.

## 26. Elements of the Fire Command

Fire commands for all weapons follow a pattern that includes similar elements. There are six essential elements that are either given or implied by using one or more of the methods of control. These six elements are—

ALERT  
DIRECTION  
TARGET DESCRIPTION  
RANGE  
METHOD OF FIRE  
COMMAND TO FIRE

*a. Alert.* This element brings the necessary men to a state of readiness to receive further instructions. The squad leader may alert the entire squad or any part of it, depending on the situation. Usually, he alerts his entire squad even though he may not command all members to fire initially. He can give the alert orally with the command SQUAD, AUTOMATIC RIFLEMEN, RIFLEMEN, or by calling to the men by name. He may give the alert by signals, personal contact, or by any other method of control.

*b. Direction.* This element indicates the general direction to the target. In some cases, it may pinpoint the exact location of point targets and the flanks or the center of linear targets. This element may be given in one or a combination of the following ways:

- (1) *Orally.* The squad leader indicates the relationship between the target location and the squad location, as shown in figure 16.
- (2) *Pointing.* The squad leader can designate a small or obscure target with his arm or rifle. When using his arm, a man standing behind him should be able to look over his shoulder and sight along his arm and index finger to locate the target. When pointing with the rifle, the squad leader places it in a rest and aims at the target. Then

he moves his head away without disturbing the rifle so any of his men can look through the rear sight and locate the target. The squad leader can use a bayonet stuck into the ground at an angle so the weapon rests in the "V" formed by the bayonet handguard and the bayonet handle. A tree fork or a log can also be used as a rest. The same thing can be accomplished by using the automatic rifle with its bipod.

- (3) *Use of tracer ammunition.* Tracer ammunition is a quick and sure method of indicating the direction to an indistinct target, and is the most accurate method of pinpointing an obscure target. When using this method, the squad leader should first give the general direction orally to direct the squad's attention to the desired area. To minimize the loss of surprise when using tracer ammunition, the squad leader does not fire until he has given all of the elements of the fire command except the command to fire. The firing of the tracer then becomes the last element of the fire command and is the signal to open fire.

*For example:*

SQUAD  
FRONT  
LINE OF RIFLEMEN  
THREE HUNDRED  
WATCH MY TRACER

Fires 1st round at *center* (automatic riflemen and center rifle-man fire)

Fires 2d round at *right flank* (ALFA fires)

Fires 3d round at *left flank* (remainder of BRAVO fires)

- (4) *Reference points.* Another method of designating obscure targets is by using easily recognizable reference points. Prominent terrain features and manmade objects make good reference points. All squad members must be familiar with the terrain features and the terminology used to describe them (FM 21-26). When using a reference

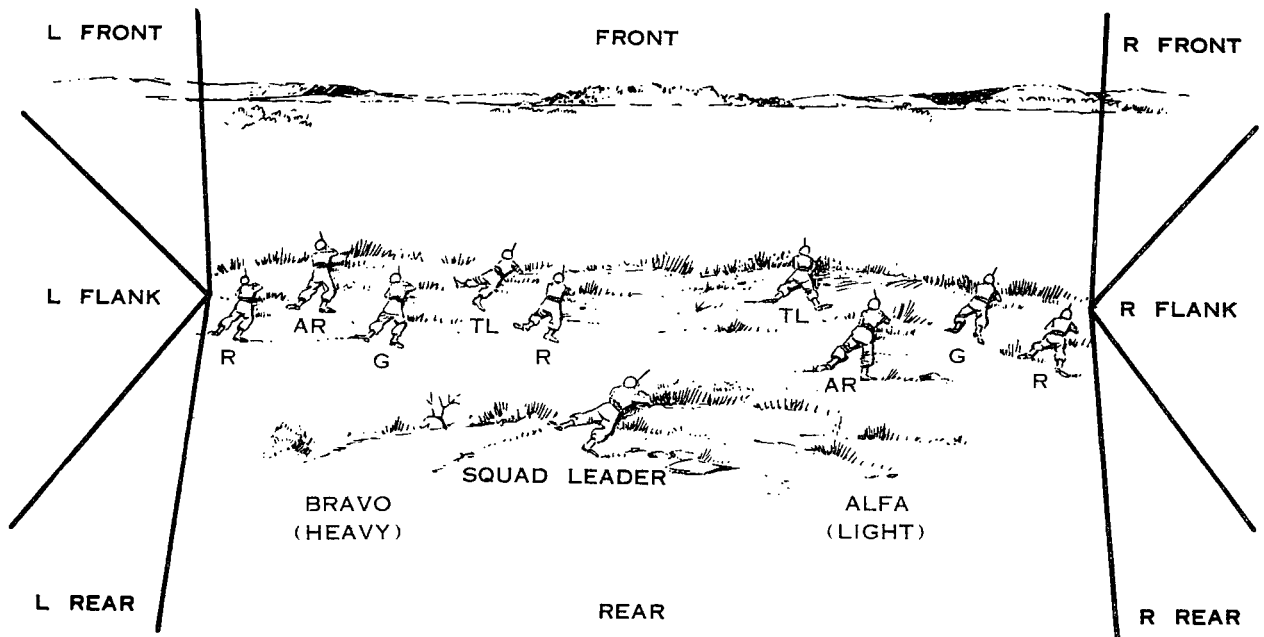


Figure 16. General direction.

point, the word REFERENCE precedes its description and the word TARGET precedes the target description. This prevents the squad from confusing the two. Always give the general direction to the reference point and the range to the target. Here are some examples of the use of reference points:

AUTOMATIC RIFLEMEN  
 FRONT  
 REFERENCE: DEAD TREE IN  
 DRAW  
 TARGET: SNIPER  
 THREE HUNDRED  
 BRAVO  
 LEFT FRONT  
 REFERENCE: TRUCK IN  
 BARNYARD, AT A  
 LESSER RANGE  
 TARGET: ENEMY COLUMN  
 FOUR HUNDRED

Sometimes a target can best be designated by using successive reference points.

For example:

SQUAD  
 LEFT FRONT

REFERENCE: STONE HOUSE,  
 RIGHT TO SMALL BARN,  
 RIGHT TO HAYSTACK  
 TARGET: MACHINEGUN  
 TWO FIVE ZERO

Finger measurements (par. 10) can be used to direct the squad's attention to the right or left of reference points.

For example:

SQUAD  
 FRONT  
 REFERENCE:  
 LONE PINE TREE,  
 RIGHT TWO FINGERS  
 TARGET: MACHINEGUN  
 TWO FIVE ZERO

*c. Target Description.* The squad members must know that type of target they are to engage to apply their fire properly. The squad leader should describe it briefly, but accurately. He always states the general formation of enemy troops, such as COLUMN or LINE. Finger measurements can be used to designate the width of a linear target when the flanks cannot be pinpointed. If the target is obvious, the squad leader need not describe it orally.

*d. Range.* Range tells the men how far to look to locate the target. It also gives the information necessary to adjust the point of aim when using the battlesight setting or make sight changes. The range is given in meters, but the words RANGE and METERS are not used. Even hundreds of meters are expressed in hundreds, i.e., ONE HUNDRED, TWO HUNDRED; otherwise, range must be expressed digit by digit such as TWO TWO FIVE or FOUR FIVE ZERO. Range is not given in less than 25-meter increments. Hand signals may be used to indicate range; for example, holding up two fingers can indicate 200 meters. This element is omitted when all men can obviously determine the range for themselves.

*e. Method of Fire.* This element includes designating the members of the squad who are to fire and the ammunition allocation.

*For example:*

SQUAD  
FRONT  
MACHINEGUN  
THREE HUNDRED  
AUTOMATIC RIFLEMEN,  
TWO MAGAZINES

If the squad leader wants the same men he initially alerted to fire, and there is no ammunition allocation, this element is omitted. Normally, the squad leader does not limit the amount of ammunition to be fired, but rather relies upon his ability to control the fires of the squad to insure proper ammunition expenditure.

*f. Command to Fire.* The squad may open fire on command or signal. If surprise fire is not required, the command FIRE is given without a pause after the method of fire element. If the squad leader wants all the men to open fire at the same time for surprise and shock effect, he precedes the command or signal to fire with the words AT MY COMMAND or AT MY SIGNAL. When all the men are ready, he commands or signals FIRE.

*For example:*

SQUAD  
FRONT  
MACHINEGUN  
THREE HUNDRED  
ONE MAGAZINE, GRENADIERS,  
THREE ROUNDS

AT MY COMMAND (pause until all members are ready)

FIRE

## 27. Formal Fire Commands

It is not realistic to expect that the squad leader's commands in combat will be as formal as those shown below. He may be able to use them in some situations when time and conditions permit. Nevertheless, they are of the utmost importance in the squad's early training to ingrain in the squad members the essential elements needed to place fire on a target, and instill in them the habit of seeking and reacting to these elements.

*a.* In the following example, the squad leader desires to place the fire of his entire squad on an easily recognizable target:

SQUAD	ALERT
FRONT	DIRECTION
LINE OF	TARGET
RIFLEMEN	DESCRIPTION
THREE FIVE	RANGE
ZERO	METHOD OF FIRE
	(omitted)
FIRE	COMMAND TO FIRE

*b.* In the example below, the squad leader desires to designate the target to his entire squad, but wants only the automatic riflemen to fire. The target is indistinct. Note the use of a reference point:

SQUAD	ALERT
LEFT FRONT	DIRECTION
REFERENCE:	
RED BARN,	
RIGHT TWO	
FINGERS	
TARGET:	TARGET
AUTOMATIC	DESCRIPTION
WEAPON	
FOUR FIVE	RANGE
ZERO	
AUTOMATIC	METHOD OF FIRE
RIFLES	
FIRE	COMMAND TO FIRE

*c.* In the following example, the squad is engaging a target and the squad leader wants to shift only the fires of the riflemen to a new target.

RIFLEMEN  
LEFT FLANK



REFERENCE: ROAD JUNCTION  
TARGET: LINE OF RIFLEMEN EX-  
TENDING RIGHT TWO FINGERS  
THREE FIVE ZERO  
FIRE

## 28. Informal Fire Commands

The following examples show how informal fire commands can be given using various methods of control. It should be noted that some of the elements of these commands are only implied, but they are very effective. After the squad members' initial training in fire commands, they should be taught to react to fire commands such as these.

*a.* In this example, the squad leader desires to place the fire of the entire squad on an automatic weapon which has opened fire on the squad from about 300 meters.

The squad leader commands WATCH MY TRACER, and engages the target.

The squad fires.

*b.* In the example below, the squad leader desires to have the rifleman of the ALFA team engage an enemy rifleman to the squad's front.

The squad leader throws a rock at the ALFA rifleman.

The rifleman turns to look at the squad leader.

The squad leader points to target and commands or signals THREE HUNDRED, OPEN FIRE.

The rifleman acknowledges, aims, and fires.

*c.* Assume that the squad is engaging a target and the squad leader wants to shift only the fire of the automatic riflemen onto a new target.

The squad leader call to the BRAVO team leader, signals that the automatic rifleman is to fire, and points to the new target. The team leader acknowledges the signal and has his automatic rifleman engage the target.

The squad leader moves to the ALFA team automatic rifleman,, points out the new target, and commands FIRE.

*d.* The squad leader wants to place the fire of both riflemen of the BRAVO team on two enemy riflemen running toward a ditch to the front.

Squad leader commands—RIFLEMEN, BRAVO TEAM—THOSE MEN, FIRE!

*e.* The squad leader wants the squad to engage a linear target. The squad leader commands LINEAR TARGET, WATCH MY TRACER. He marks the limits of the target by firing tracer ammunition. The SQUAD FIRES.

## CHAPTER 3

### FIELD AND LANDSCAPE TARGET FIRING

---

#### Section I. INTRODUCTION

#### 29. General

The second phase of technique of fire training is designed to give the squad members practice in applying their fire as a team. It requires the squad to apply all of the fundamentals learned in the first phase and other skills learned during individual training, such as marksmanship and the use of cover and concealment. This training also provides for integrated and concurrent training in related subjects such as basic squad tactics.

#### 30. Types of Training

*a. Field Target Firing.* This training is conducted on a field target firing range (fig. 17)

and teaches the squad how to engage simulated enemy targets under conditions closely related to combat. The squad is in a tactical defensive position, or deploys from a combat formation to engage various types and combinations of enemy targets. This training is particularly valuable because of its combat realism.

*b. Landscape Target Firing.* This training is conducted on a 25-meter range and the squad fires at panoramic pictures of the landscape (fig. 18). Landscape target firing is a substitute for field target firing when the facilities for field target firing ranges are not available. It can also be used to better prepare a unit for field target firing, or to review and maintain proficiency in technique of fire training.

#### Section II. FIELD TARGET FIRING

#### 31. Range Facilities

*a. General Characteristics.* Figure 17 shows a schematic diagram and the dimensions of a field target firing range. The firing line should be irregular and include features that offer cover and concealment such as folds in the ground, stumps and brush, and other features that offer cover and concealment and good firing positions. It is desirable that the firing line be 250 to 300 meters wide so the squads can select different positions for the various exercises. The range should be at least 460 meters in depth so targets can be engaged out to the maximum effective range of the squad weapons. Terrain should be such that the squad members get plunging fire so they can better observe and adjust their fire. The rear area of the range should include facilities for critiques and concurrent training in related subjects.

*b. Personnel Pits.* A and B, figure 94 show the design of the personnel pits when the M79

grenade launcher is used during the firing exercises. When the M79 is not used, as would be the case during basic combat training, the personnel pits can be designed as shown in C, figure 94. From these pits, the various types and combinations of targets are presented to the squad during an exercise. The number of pits used will depend on available facilities, personnel, and time. Four pits are ideal and will provide a wide variety of exercises. Two pits are considered the minimum number for sufficient variety. The pits are staggered so they do not mask each other (fig. 17). Each pit has telephone communications with the control point for safety and coordination.

*c. Targets and Simulators.*

(1) *Targets.* E, F, and M type silhouettes are arranged to represent the enemy in linear and column formations, machinegun crews, and various targets of opportunity (sniper, moving, and bobbing) (figs. 17, 19, and 20). The targets are camouflaged as appropriate.

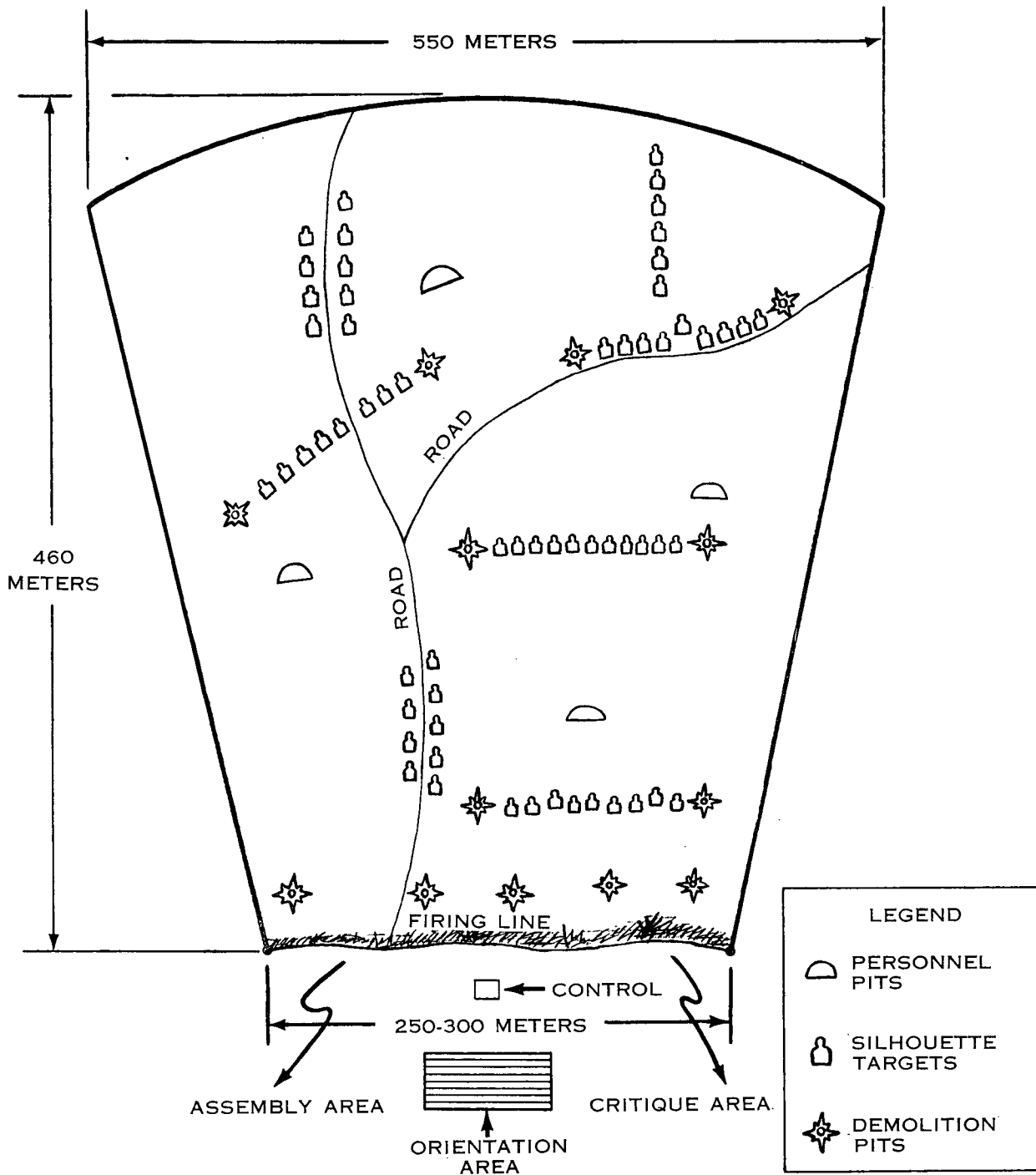


Figure 17. Field target firing range.

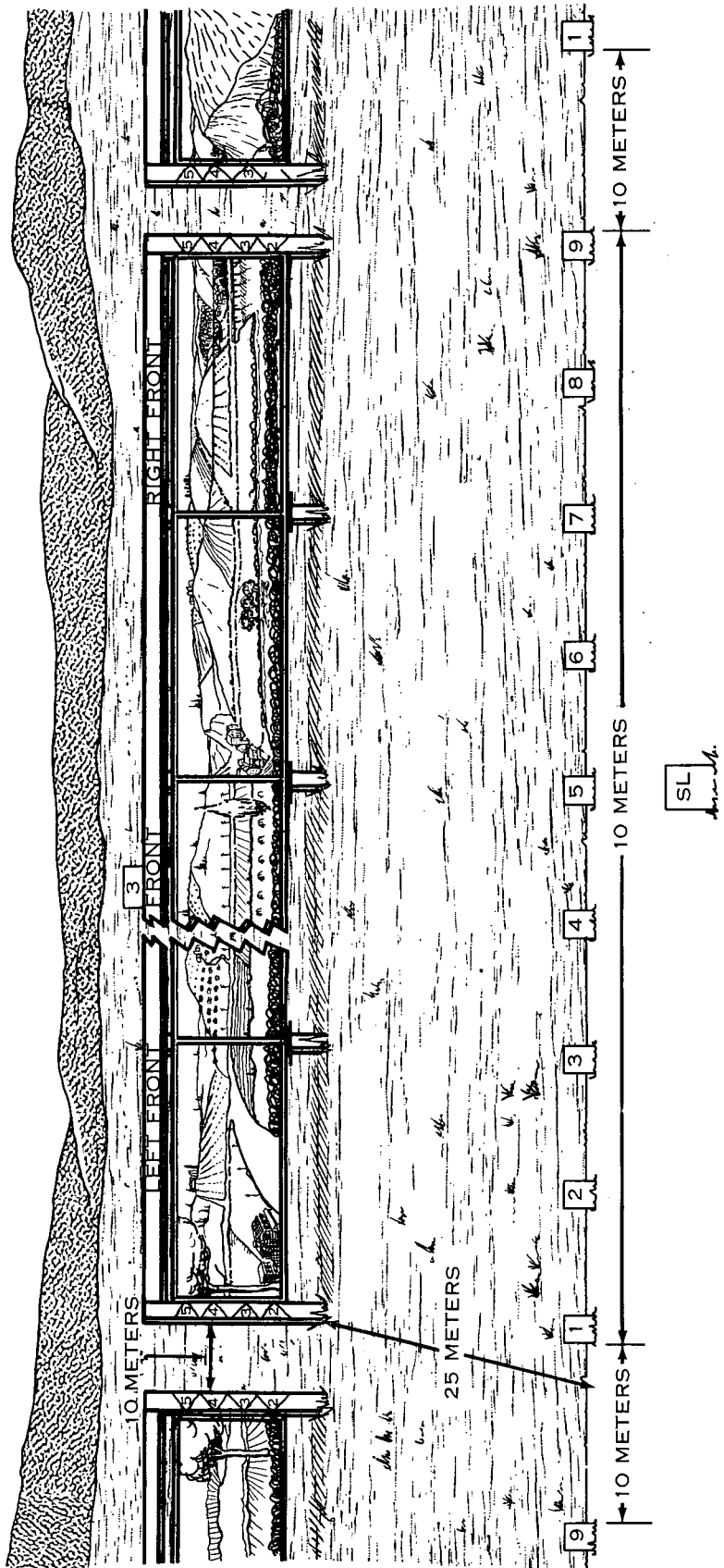


Figure 18. Landscape target firing range.

- (a) Groups of nine to 12 E and F type silhouettes make good linear targets. The flanks of these targets are designated to the squad by exploding demolitions on each flank (fig. 96) or by raising the targets as shown in figure 95. E or M type silhouettes arranged in a column formation represent surprise targets for the squad.
  - (b) Machineguns placed in separate pits (figs. 86 and 87) and loaded with ball or blank ammunition can be used to simulate enemy machinegun targets. F type silhouettes are placed around the machinegun in a 15-meter square to represent the gun crew.
  - (c) The sniper target is an E type silhouette which is exposed for a few seconds (between 5 and 10), and represents an enemy sniper firing on the squad. It is controlled from a pit by a series of pulleys and cables (figs. 88 and 89).
  - (d) The moving target is an E type silhouette representing an enemy ammunition bearer of a crew-served weapon. It is mounted on a dolly sled and pulled into view by cables (figs. 90 and 91).
  - (e) The bobbing target is a silhouette representing an enemy soldier moving toward the squad's position. It is mounted on a pole and is moved from side to side by the pit operator (fig. 94).
- (2) *Simulators.* Added realism can be obtained by simulating mortar, artillery, and rifle fire.
- (a) Demolitions exploded in pits near the squad's position represent incoming mortar or artillery fire.
  - (b) Rifles loaded with ball ammunition, placed in protected positions near the linear target formations, can be used to give the target indications of smoke, dust, and flash. The pit operator fires the rifles by a series of pulleys and cables (figs. 92 and 93).

## 32. Firing Exercises

All exercises should require the squad to practice the fundamentals of fire control and application of fire, i.e., initiating, distributing, concentrating, and shifting fire. During basic combat training the soldier participates in squad field target firing exercises. These exercises must be conducted periodically thereafter in order to maintain proficiency in the technique of fire. The following are examples of exercises conducted during field target firing.

*a.* The squad is deployed in a defensive position and required to place surprise fire on a column target. It is then required to shift fire from this column to a linear target which represents the enemy column deploying into a linear formation. After the squad initiates fire, a machinegun target and other targets of opportunity are presented.

*b.* While moving forward in a combat formation, the squad receives surprise fire from a linear target. After the squad returns fire, a machinegun target and targets of opportunity are presented.

*c.* The squad is deployed in a defensive position and presented with two linear targets simultaneously. After the squad initiates fire, a machinegun target and other targets of opportunity are presented.

*d.* While moving forward in a combat formation, the squad receives surprise fire from an enemy machinegun. After the squad returns fire, a linear target and targets of opportunity are presented.

## 33. Conduct of Training

*a. Review of Fundamentals and Marksmanship.*

- (1) *Fundamentals.* Although the squad must call on all its prior training in technique of fire to conduct field target problems successfully, the two fundamentals that must be stressed are *Application of Fire* and *Fire Control* (pars. 14-28). As a minimum, these two fundamentals and the method of searching terrain by observation (FM 21-75) should be thoroughly reviewed before firing field target problems. The

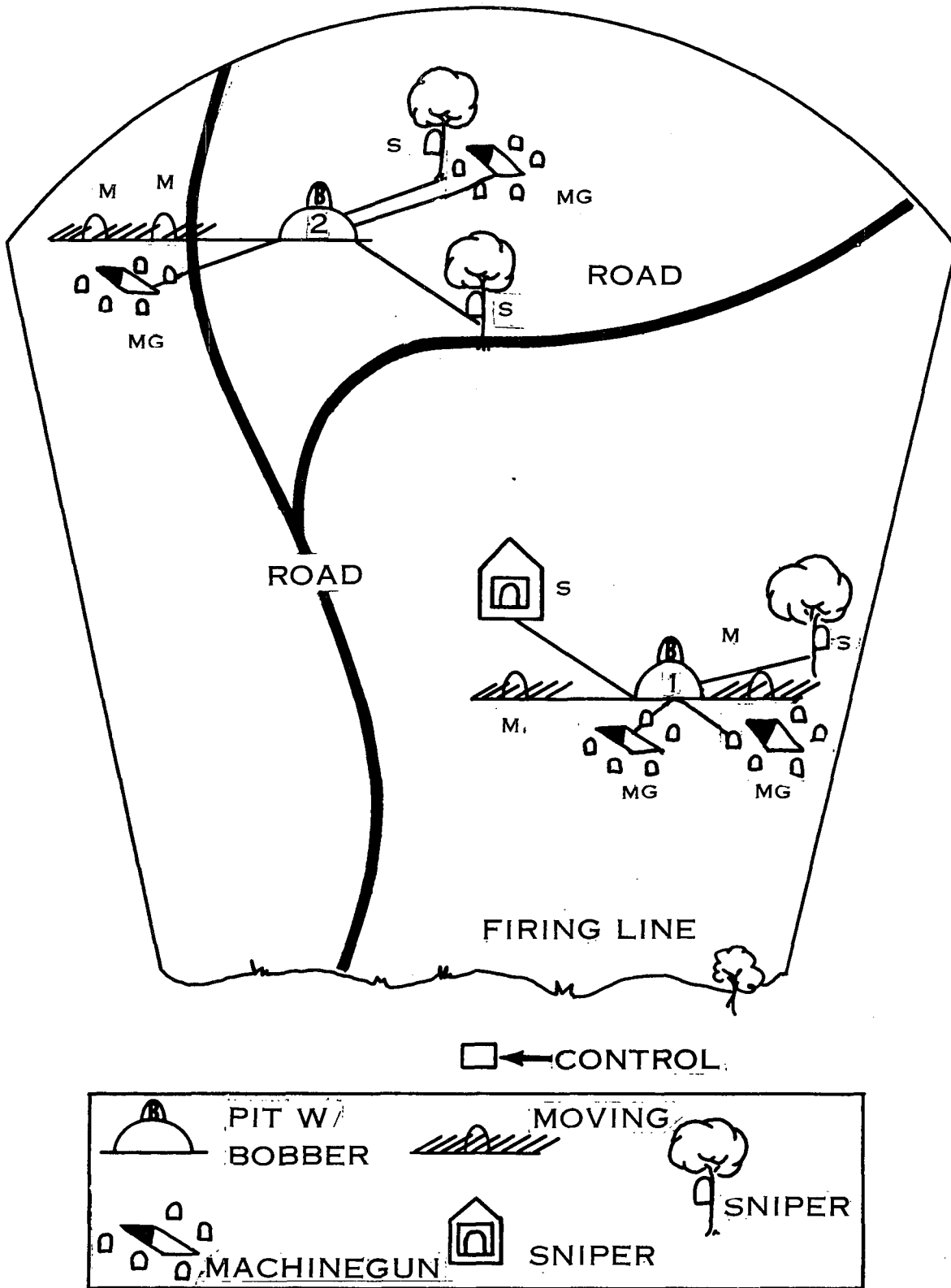
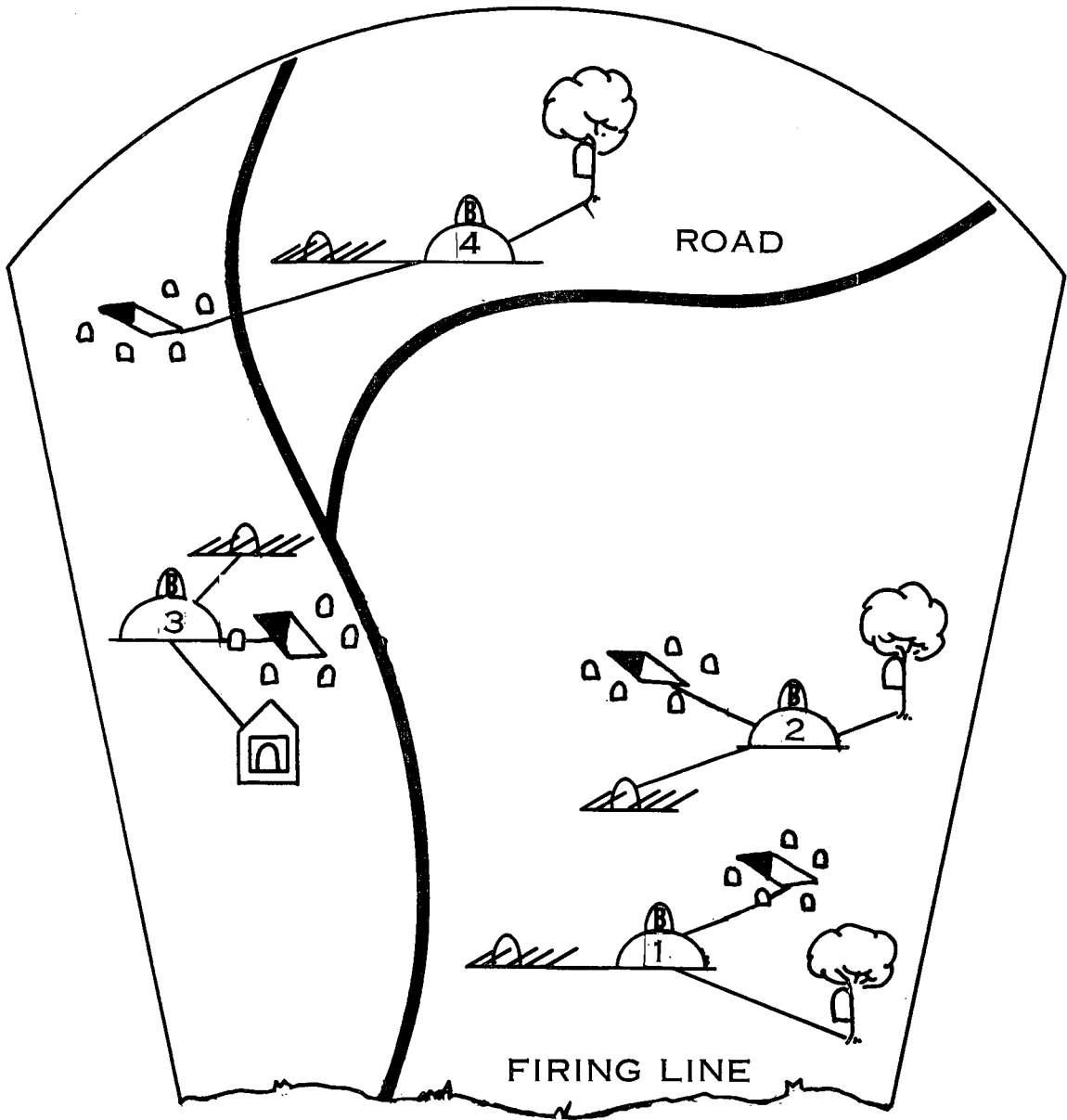


Figure 19. Targets of opportunity arrangement with two pits.



◻ ← CONTROL

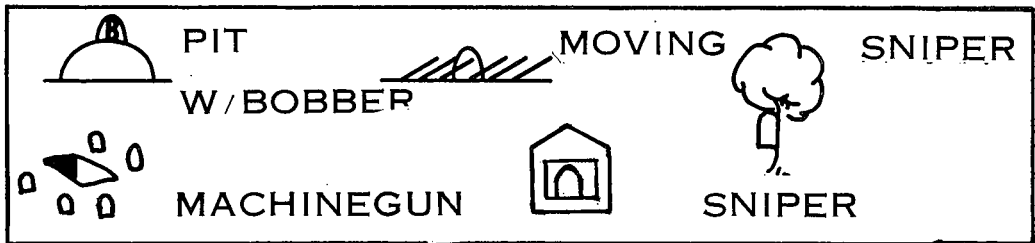


Figure 20. Targets of opportunity arrangement with four pits.

importance of teamwork should be stressed throughout this training.

- (2) *Marksmanship.* Prior to conducting field target firing, the squad members confirm the zero of their weapons. The technique of adjusting the point of aim ("hold-off") when using the battlesight setting should be reviewed.

*b. Conduct of Firing.* Following a review of the fundamentals and instructions on the safety regulations for the range (app. III), the squads which are to fire first are moved to an assembly area. The remaining squads move to concurrent training stations as set forth in *f* below. The same procedure is used to conduct all field target exercises. However, the purpose and situations, target locations, and actions required of individuals will be different for each exercise.

- (1) In the assembly area, the squad is briefed on the purpose of the exercise and the tactical situation, and is issued its ammunition. Riflemen and team leaders receive 25 rounds each, automatic riflemen 70 rounds each, and, if grenade launchers are used, the grenadiers receive four rounds each. (See app. III for special safety precautions pertaining to the grenade launcher.) This is enough ammunition for an exercise lasting approximately 3 minutes. A purpose and tactical situation that could be used in conjunction with the exercise described in paragraph 32*a* would be—

- (a) *Purpose.* To give the squad practice in applying its fire on a column target, shifting its fire when the column deploys into a linear formation, and engaging a machinegun and other targets of opportunity.
- (b) *Situation.* Your squad is deployed in a defensive position. You have not had time to dig in, but are making the most of the cover and concealment the terrain affords. You are in position when the enemy appears.

- (2) Having been told the purpose of the exercise, issued its ammunition, and given a tactical situation, the squad is given a few minutes to make any final

coordination, and then moves to the firing line.

- (3) When the squad is in place, the exercise begins. The sequence would be as follows:

- (a) The squad leader designates the column target and the squad fires simultaneously.
- (b) After the squad has engaged the column target for approximately 30 seconds, demolitions explode on the flanks of a linear target indicating that the enemy has deployed into a linear formation. The squad would then shift its fire to the linear target.
- (c) While the squad is firing on the linear target, the machinegun target is activated. The squad leader then has the appropriate weapons shift and engages the machinegun target (par. 84*d*).
- (d) Additional targets of opportunity are then presented (moving, sniper, and bobbing). The riflemen in whose sector these targets appear shift their fire and engage them. If the targets of opportunity are not engaged, they are presented a second time and this error is noted for the critique.

- (4) Upon completion of the exercise, the squad leader is given a signal to have the squad cease fire. The weapons are cleared by the safety personnel and the squad moves to a critique area. If at any time during the exercise it becomes obvious that too many errors are being committed, the exercise is stopped and corrections are made.

*c. Problem Critique.* Immediately following the exercise, the squad is taken to a critique area. Here the purpose of the exercise is reviewed and the squad is critiqued. The squad is critiqued on how it applied the fundamentals of technique of fire and related training as follows:

- (1) Orders of the squad leader.
  - (a) Preparation for action: check of equipment and ammunition, duties of individuals, and initial order.



- (b) Orders for and during the action.
- (2) Use of combat formation.
- (3) Actions of individuals.
  - (a) Selection of firing positions.
  - (b) Use of cover and concealment.
  - (c) Individual initiative.
  - (d) Fire discipline.
  - (e) Compliance with orders.
- (4) Fire control.
  - (a) Rate of fire: initially rapid in order to gain fire superiority, and controlled to insure maximum effect of fire to conserve ammunition.
  - (b) Fire commands and use of SOP's.
  - (c) Application of the methods of control.
- (5) Application of fire.
  - (a) Distribution of fire.
  - (b) Concentration of fire.
- (6) Scoring the effect of fire.
  - (a) Distribution score.
  - (b) Accuracy score.

*d. Problem Scoring.* Any scoring system which gives credit for distribution of fire and accuracy may be used. For example, five points may be given for each silhouette hit plus one point for each hit not to exceed five in any silhouette. In this example, the maximum score for any one silhouette cannot exceed 10 points (five hits). This discourages firing on only those silhouettes that are easy to detect, and is an incentive for proper distribution of fire over the entire target area. The highest possible score for any given problem depends on the number of silhouettes used. For example, if 15 targets are used, the possible score would be 150. The score is announced at the end of the problem in the critique area. (See fig. 80 for a recommended score chart.) It represents only a portion of the squad's performance. The squad's rating on the items covered in *c* above are equally important.

*e. Safety Precautions.* The safety precautions for field target firing exercises are covered in appendix III.

*f. Concurrent Training.* To make maximum use of training time on the field target firing range, concurrent training should be conducted. The county fair system of movement through concurrent training stations is recommended

(fig. 21). Subjects covered in the concurrent training stations should be limited to the fundamentals of technique of fire and related subjects. The following subjects and methods of organizing the concurrent training stations are recommended:

- (1) *Range determination.* The following exercises are designed to give the soldier a thorough understanding of the principles used in estimating range by eye.
  - (a) *Exercise No. 1.* The purpose of this exercise is to familiarize the soldier with the 100-meter mental unit of measure on varied terrain. From an observation line out to 500 meters, panels are placed at 100-meter intervals to show what 100-meter units of measure look like on different types of terrain and at different ranges. The exercise begins at the 400-meter panel with the squad members formed facing the 500-meter panel. They are given an opportunity to fix this 100-meter mental unit of measure firmly in their minds. They repeat this exercise at the 300-, 200-, and 100-meter panels. At each panel, they study the appearance of these 100-meter units of measure and apply them successively up to 500 meters. The unit receiving the instruction may be divided into two or more groups which are rotated over several courses in the area.
  - (b) *Exercise No. 2.* The purpose of this exercise is to provide practice in determining range by using the 100-meter mental unit of measure. Ranges are measured from an observation line(s) to various objects within 1,000 meters. The objects should be situated so the range to one object cannot be used to determine the range to another. The instructor points out five or six objects and the men enter their estimates on worksheets. Thirty seconds or less are allowed for each estimate. After the men have recorded

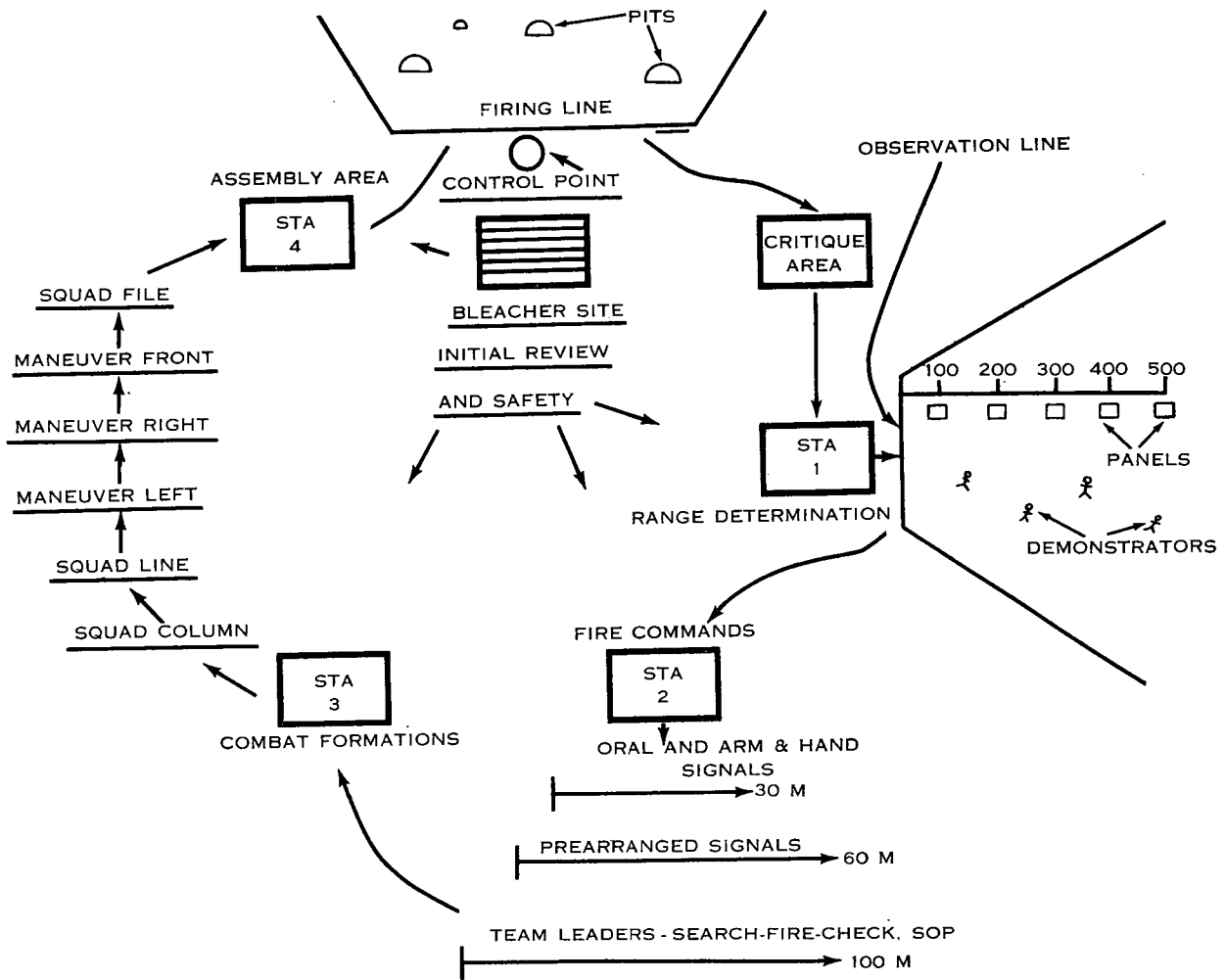


Figure 21. Concurrent training areas.

their estimates, the instructor announces the true ranges and requires the men to analyze their errors and jot down the reason on the worksheet. Interest and competition can be developed by maintaining and comparing scores.

- (c) *Exercise No. 3.* The purpose of this exercise is to familiarize the soldier with the method of determining range by the appearance of objects. From an observation line overlooking varied terrain, five demonstrators are posted in concealed positions at 100-meter intervals out to 500 meters. The squad is moved to the observation line. On signal,

all the demonstrators stand up. The instructor points out that the men seem to decrease in size as the distance to them increases. He calls attention to the gradual disappearance of details (facial features, hands, arms, legs, helmet, belt, and rifle). On signal, the demonstrators kneel. The squad then studies the kneeling figures. The instructor calls the class's attention to the details of the kneeling men, pointing out that they seem to disappear at much shorter ranges than when they were standing. On signal, the demonstrators take up the prone firing position and aim their rifles

at the squad. The squad studies the appearance of the prone figures. The instructor points out that fewer details are visible, even at the shorter ranges. The squad members should be required to practice this method of determining range until they become proficient.

- (d) *Rules for instructors.* Know the exact ranges used in the exercises. Announce the ranges to each target after the men have made their estimates and explain why an object appears to be nearer or more distant. Move to new terrain as often as possible and teach each man to make his estimate without props or other aids. Teach the men to consider the terrain between them and the target. Use typical combat targets or reference points such as trees, bushes, rocks, ridge lines, edges of woods, weapons positions, buildings, and bridges. Use varied backgrounds such as the sky, woods, open fields, and bodies of water. Give the men practice in estimating ranges out to 1,000 meters, but concentrate on ranges within 500 meters.

- (2) *Fire commands.* The purpose of this training is to give the squad practice in responding to fire commands and the various methods of control. It is

conducted in an area where the squad leader can give fire commands to his squad while it is deployed in three successive defensive positions 30, 60, and 100 meters in width. First the squad is deployed in a position 30 meters in width and the squad leader gives fire commands orally and by using arm-and-hand signals. The squad leader then moves his men to the 60-meter position and gives fire commands by prearranged signals. Finally, the squad leader moves his squad to the 100-meter position and gives fire commands by passing orders from man to man.

- (3) *Combat formations.* A concurrent training station for combat formations can be organized by using a series of substations where the squads practice the squad file, squad column, and squad line (pars. 76-79), and the three basic battle drill maneuvers (par. 89). The terrain should be suited to the type formation or maneuver being used.
- (4) *Actions in the assembly area.* This training consists of instruction and practice in the actions of the squad in an assembly area such as receiving the order, checking equipment, and drawing ammunition. The squad is sent to this station just prior to conducting its live fire exercise, and this training is conducted as part of the exercise.

### Section III. LANDSCAPE TARGET FIRING

#### 34. General

In order to provide training in technique of fire for units having limited range facilities, landscape target firing can be conducted instead of field target firing. Landscape target firing can also be used to maintain proficiency in technique of fire, and better prepare a unit for field target firing.

a. Landscape target firing is not as realistic as field target firing and prohibits the use of grenade launchers; however, it is an effective means of—

- (1) Teaching the squad members the

standard methods of applying their fire.

- (2) Giving the squad members practice in responding to fire commands.
- (3) Teaching the squad members to respond to various methods of fire control.

b. It has these advantages over field target firing—

- (1) It permits closer supervision of individuals.
- (2) It can be conducted in a limited area, and requires less preparation time.

- (3) It can be conducted indoors when lack of outdoor facilities or weather conditions will not permit outdoor firing.
- (4) The firing can be conducted with the .22 caliber rifle.

### 35. Range Facilities

*a. General Characteristics.* Figure 18 shows a typical landscape target firing range. This range can be superimposed on an existing range or set up on any relatively level area 25 meters in depth. In either case, the range must meet the safety requirements for the ammunition being used. Each squad will occupy an area approximately 10 meters in width. Stakes numbered from one to nine designate the firing positions for the squad members. The squad leader, who does not fire, is placed to the rear of the squad. To avoid confusion the squad positions should be approximately 10 meters apart. The rear area of the landscape target range, like the field firing range, should have facilities for concurrent training stations.

*b. Targets.* A landscape target is a panoramic picture of a landscape drawn so all of the prominent terrain features are recognizable at a distance of 25 meters. The standard target series consists of two sets of five panels each (landscape target series A). One set (five

panels placed side by side in a target frame) represents one squad sector of fire (figs. 18 and 22).

- (1) *Range indicators.* Numbers are painted on the sides of the target to represent ranges in 100-meter increments (fig. 18). This enables the squad leader to give a simulated range and assists the squad in locating the target.
- (2) *Direction indicators.* Direction is indicated by painting the word FRONT, RIGHT FRONT, or LEFT FRONT above the appropriate panels (fig. 18).

### 36. Weapons and Zeroing

*a. Weapons.* The service rifle and automatic rifle are used to conduct landscape target firing. Since the grenade launcher is not used, the grenadiers act as riflemen or automatic riflemen during this training. The .22 caliber rifle can also be used to conduct this training.

*b. Zeroing.* Since the battlesight zero cannot be used, rifles are zeroed for 25 meters. The center panoramic target panel is removed and replaced by a blank panel. Nine standard black target pasters (2.5 centimeter squares) are placed on this panel as shown in figure 22. These pasters are used as aiming points. To aid the

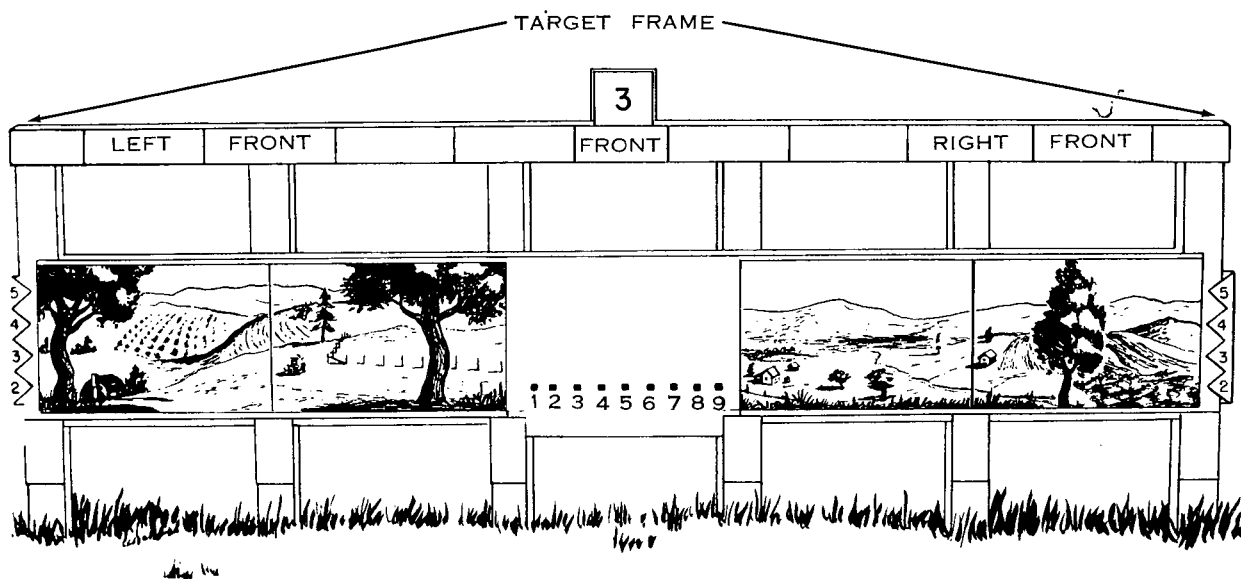


Figure 22. Landscape target with zero panel.

firer in locating his aiming point, each paster is numbered as shown in figure 22. The zeroing procedure is as follows:

- (1) The sights are blackened and the squad is deployed on the firing line.
- (2) Each firer sets his sights at 12 clicks elevation and zero windage (sight settings for .22 caliber rifles will vary with make or model).
- (3) The squad members are assigned the aiming point corresponding to their numbered position on the firing line.
- (4) Each man fires a three-round shot group.
- (5) The pasters are inspected and the necessary sight changes are made. At 25 meters, one click of windage or elevation on the M14 rifle will move the strike of the bullet .7 centimeters.
- (6) The procedures in (4) and (5) above are repeated as needed to zero each rifle.
- (7) After the weapons are zeroed, the zeroing target is replaced by the panoramic target.

### 37. Conduct of Training

#### a. Ammunition.

- (1) Each fire is issued 9 rounds for zeroing.
- (2) The squad is issued 55 rounds per exercise, distributed as follows:
  - (a) Team leaders and riflemen—5 rounds each.
  - (b) Automatic riflemen — 10 rounds each.

b. *Conduct of Firing.* Landscape target firing exercises are conducted as follows:

- (1) The squads zero their weapons as described in paragraph 36b.
- (2) The squad is faced away from the targets and the target is pointed out to the squad leader.
- (3) On command the squad faces the target and assumes the prone position.
- (4) At this time the squad leader takes charge of his squad and issues a fire command and the squad engages the target using appropriate techniques.

- (5) After each exercise weapons are cleared and the squads are moved to the landscape target where they are critiqued. The score is recorded and compared to the scores of other squads.
- (6) Each squad should fire a minimum of four exercises. Training should progress from the simple exercises (firing at single linear, single column, or single point targets) to the more complex exercises (firing simultaneously on two or more targets). Exercises should also be included that will require the squad or portions of it to shift fire.

c. *Safety Precautions.* The safety precautions for landscape target firing are covered in appendix III.

d. *Concurrent Training.* Subjects appropriate for concurrent training and methods of presenting them are contained in paragraph 33f.

### 38. Scoring

a. *Scoring Templates.* The squad fires at linear, column, and point targets. Templates are used to define the target area for scoring purposes. The templates are made from either celluloid, cardboard, or similar material (figs. 23 and 24).

- (1) The template for scoring linear and column targets is a rectangular frame with an outer scoring area 13 centimeters high and an inner scoring area seven centimeters high. The template is long enough to cover the width or depth of the target. Since the squad is taught to distribute its fire beyond the known flanks of linear targets, the template must overlap the flanks 2.5 centimeters (fig. 23).
- (2) The template for point targets is a rectangular frame with an outer scoring area of 10 x 13 centimeters and an inner scoring area of 5 x 7 centimeters (fig. 24).
- (3) The templates are used to line in scoring areas for each target.

b. *Scoring.* Prior to each exercise, the scoring areas are traced on the panoramic target.

For linear or column targets, the template is placed with the inner scoring area centered on the target so the long axis of the template runs parallel to the long axis of the target. The inner and outer scoring areas are then traced in pencil. This trace should not be visible from the firing line. The target is then divided into five equal spaces regardless of target width or depth (fig. 22). These five spaces are known as distribution spaces. The squad receives two points for each hit in the inner scoring area, and one

point for each hit in the outer scoring area. No more than 11 hits are counted for score in any distribution space. Point targets are marked and scored in the same manner except there are no distribution spaces to consider. The maximum score is 110 points. For example, if a squad fires all of its ammunition (55 rounds) at a linear target and gets a perfect distribution score (11 hits in each distribution space in the inner scoring area), it gets a score of 110 points ( $2 \times 55 = 110$ ). Hits cutting or touching a line count where they have the most value.

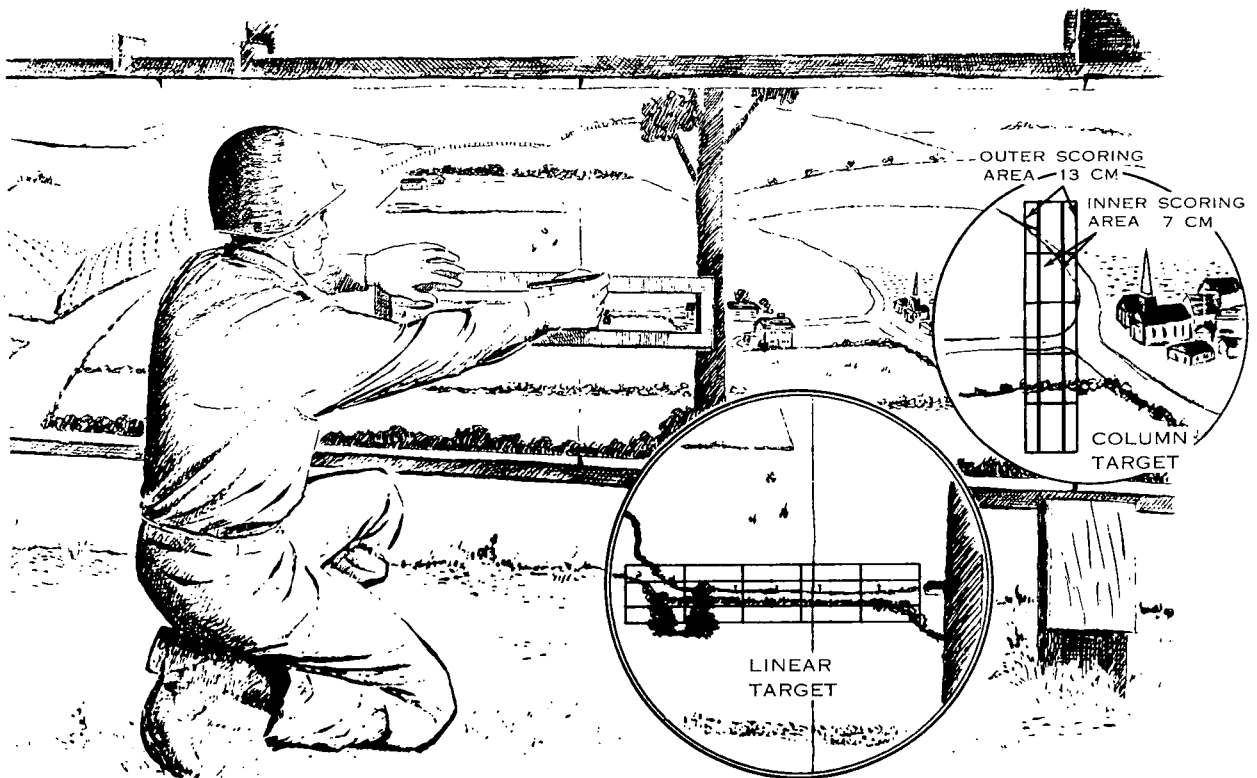


Figure 23. Template for marking linear and column target scoring areas.

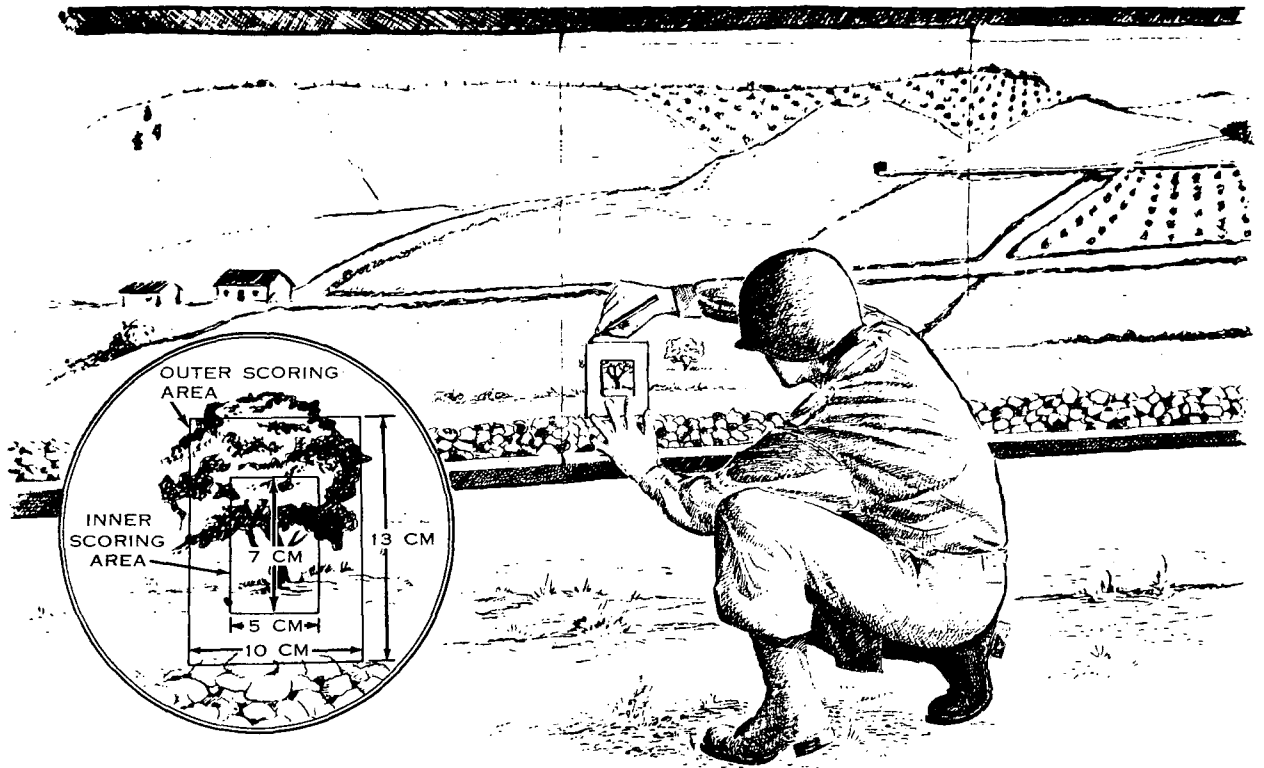


Figure 24. Template for marking point target scoring areas.

## CHAPTER 4

### TECHNIQUE OF FIRE DURING PERIODS OF LIMITED VISIBILITY

---

#### Section I. INTRODUCTION

##### 39. General

This chapter provides for training in rifle squad defensive and assault firing techniques during periods of limited visibility. Artificial illumination may not always be effective, available, or desirable. Therefore, the squad must be able to apply and control its fires at night and during daytime operations when visibility is limited by smoke, fog, or snow. Daytime techniques of applying and controlling squad fire must be modified to accomplish this. These modified techniques are used both at night and during daylight operations when visibility is limited. Training in technique of fire during

periods of limited visibility is conducted at night since this is the most common period of limited visibility. For this reason, the training is referred to as squad defensive and assault night firing.

##### 40. Prerequisites

a. Night vision, individual night firing, and daytime techniques of fire instruction should be reviewed prior to squad defensive and assault night firing.

b. Prior to conducting live fire exercises during the hours of darkness, troops should have at least one-half hour for dark adaptation.

#### Section II. FUNDAMENTALS OF SQUAD DEFENSIVE NIGHT FIRING

##### 41. General

a. The squad will encounter several difficulties while defending during periods of limited visibility which seriously hamper the use of daylight techniques.

- (1) During periods of limited visibility, the squad sector cannot be surveyed in depth as in the daytime. No single man can see the entire squad front. Normally, visibility will be such that targets will be detected only by the man in whose sector they appear. During periods of extremely limited visibility, it may be impossible to detect targets in the squad sector.
- (2) Targets appearing in the squad sector will be so close to the squad's position when they are detected that there is not time to alert other squad members and wait for the squad leader's decision as to when and where to fire.
- (3) Normally the squad leader cannot see (except in his immediate vicinity)

either his men, the terrain, or the enemy. Therefore, he cannot control squad fires by selecting targets and directing fire on them as he does during the daytime. Very few of the methods used by the squad leader to control fire in daylight are of any use during periods of limited visibility. Voice commands are not dependable, arm-and-hand signals cannot be seen, and it is difficult for the squad leader to move fast enough to use personal contact effectively.

- (4) At night there is a tendency for the squad members to fire indiscriminately at noises, suspected enemy locations, and targets that are not appropriate for their weapons. This type of fire will waste ammunition and prematurely disclose the squad's position.

b. In order to overcome the difficulties encountered during periods of limited visibility,



special techniques must be developed to insure proper—

- (1) *Surveillance of the squad sector* so all targets appearing within the limit of visibility will be detected.
- (2) *Application of fire* so all targets appearing in the squad sector will be effectively engaged by appropriate weapons.
- (3) *Fire control* so squad fires can be initiated, distributed, shifted, concentrated, and ceased at the proper time and with minimum control by the squad leader.
- (4) *Ammunition conservation* by firing only when appropriate targets appear on when ordered to deliver preplanned fires.

#### 42. Surveillance of the Squad Sector

To insure that all targets appearing within the limit of visibility are detected, the squad sector is divided into individual sectors for surveillance purposes.

*a. Team Leaders and Riflemen.* At night each team leader and rifleman searches that portion of the squad sector which corresponds to his position in the squad *out to the limits of visibility* (fig. 25). This gives each team leader and rifleman responsibility for approximately one-fifth of the squad sector. To insure an overlap of individual sectors, much closer coordination is necessary than in daylight. This may require marking the sectors with a stake or other objects placed out to the limits of visibility between positions. The occupant(s) of a fox-hole is (are) responsible for insuring continuous contact between foxholes or with adjacent squads. This system insures complete surveillance of the squad sector and prevents enemy penetrations between individual or squad positions.

*b. Automatic Riflemen and Grenadiers.* Since the automatic riflemen and grenadiers are responsible for engaging targets anywhere in the squad sector, they are not normally assigned an individual sector for surveillance. They watch for and fire on targets which become visible anywhere in the squad sector.

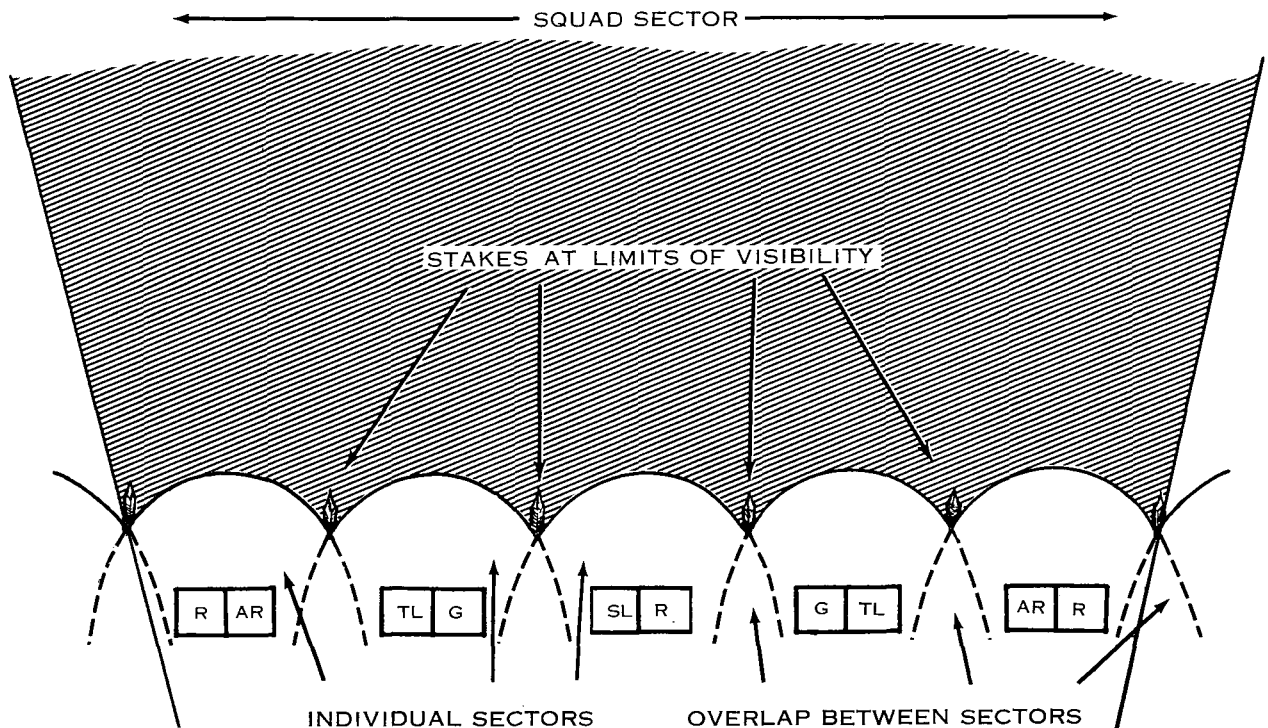


Figure 25. Surveillance by team leaders and riflemen during periods of limited visibility.

However, the type of terrain, personnel shortages, or degree of visibility may make it necessary to assign individual sectors to automatic riflemen and grenadiers to insure complete coverage of the squad sector.

### 43. Application of Fire

Normally, only two types of targets will appear in the squad sector: assaulting enemy personnel; and supporting automatic weapons. Such targets will have priority whenever they become visible to the squad members. The squad members must be able to effectively engage these visible targets and also deliver preplanned fires on order.

*a. Visible Targets.* In order to insure the most effective engagement of visible targets and prevent indiscriminate firing, the following techniques are applied.

- (1) *Team leaders and riflemen.* Team leaders and riflemen fire only at targets they can see well enough to align their weapons on, using the pointing technique—assaulting enemy personnel. They do not fire at the flashes of enemy automatic weapons unless ordered to do so by the squad leader as an expedient measure.
- (2) *Automatic riflemen.* The primary targets for automatic riflemen are *enemy automatic weapons* in the squad sector that are firing effectively on the squad or other friendly elements. In order to engage such targets effectively, the field expedient sight described in figure 26 must be used. The field expedient sight, when used with the bipod, enables the automatic rifleman to hold the sights into alignment with the flash of an enemy automatic weapon. Using the muzzle flash of an enemy automatic weapon as their aiming point and firing in 3- to 5-round bursts, the automatic riflemen can place a heavy volume of fire in the area of the enemy weapon. When using the field expedient sight, the rear sight is set at zero elevation. This setting will enable the automatic riflemen to place effective fire on visible targets at ranges out to 250 meters.

Experience has shown that enemy automatic weapons supporting a night attack will normally be within 250 meters of their objective. In the absence of his primary target, the automatic rifleman will fire at assaulting enemy personnel.

- (3) *Grenadiers.* The primary target for grenadiers is enemy automatic weapons. In order for their fire to be effective against muzzle flash targets, the grenadiers must have sufficient illumination to either determine the range and adjust their fires or their fires must be preplanned. In the absence of primary targets, the grenadiers fire at assaulting enemy personnel, using the pointing technique.

*b. Preplanned Fires.* In addition to engaging appropriate visible targets, which have priority at all times, the squad members must be able to deliver preplanned fires during periods of extremely limited visibility. These fires can be used to cover likely avenues of approach, anticipated enemy automatic weapon positions, and probable enemy assault positions. Such preplanned fires would be delivered on order only and could be used to break up an enemy attack before it reached the assault stage. Preplanned fires can also be used to provide mutual fire support within the squad by having individuals cover portions of adjacent sectors that are defiladed from other squad members. The field expedients for delivery of this preplanned fire must be emplaced and their alignment verified during daylight. Preplanned fire data should be recorded on a range card or sector sketch.

- (1) *Rifles and automatic rifles.* Preplanned grazing fire can be delivered with rifles and automatic rifles by using field expedients as shown in A and B, figure 27. The weapon is placed in the rests and zeroed to hit the desired point or cover a sector with grazing fire. The rests are adjusted so that when the weapon is placed in them, it will be pointing in the desired direction and will hold the weapon at the desired elevation. To fire from the

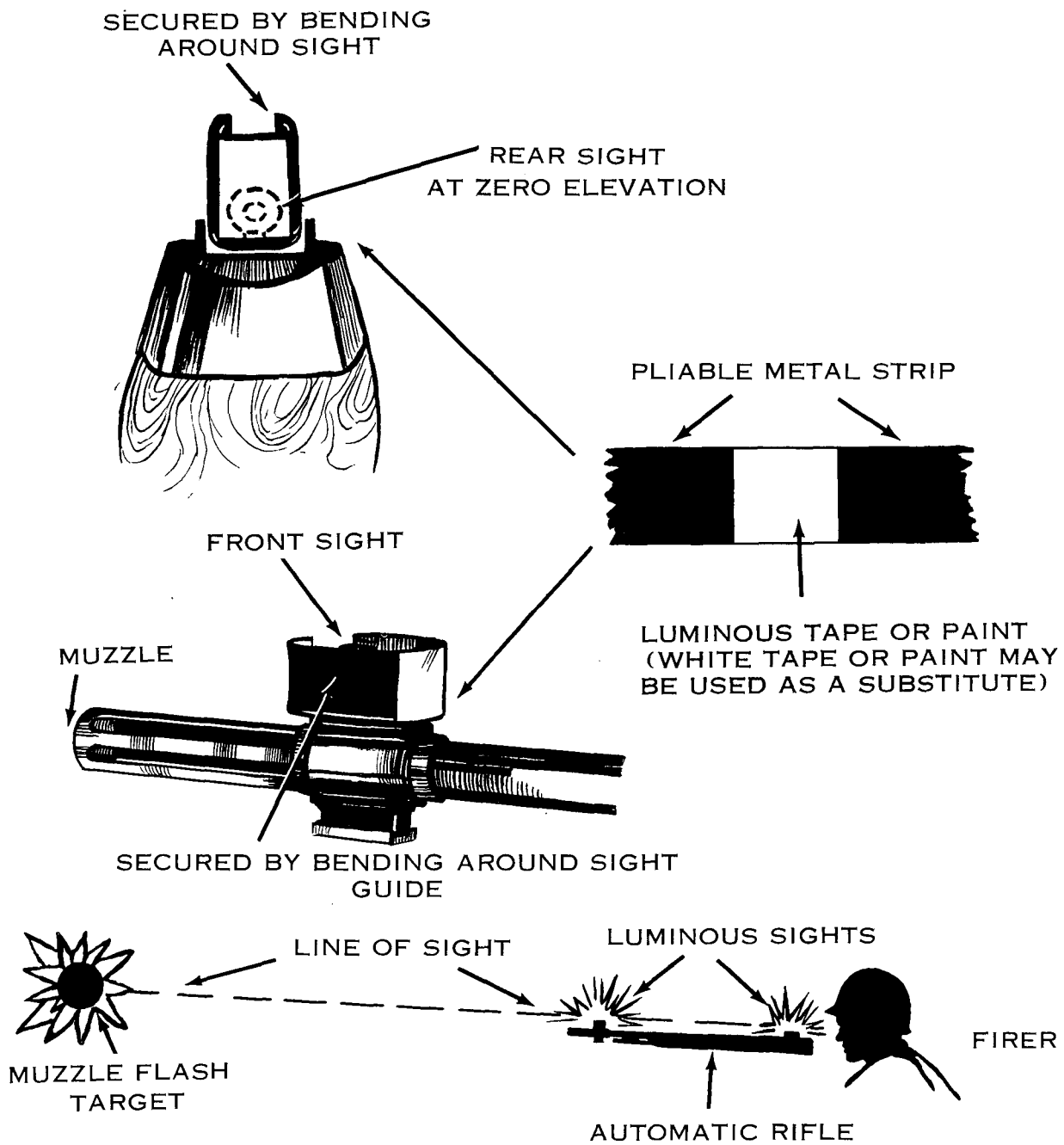


Figure 26. Field expedient night sight and sight picture for the automatic rifle.

rest, the individual places the weapon in the rests with his right shoulder firmly against the butt. He can deliver grazing fire across his sector or at a point target as rapidly as he can manipulate the trigger. He must hold the weapon in the rests in the exact position in which it was held when it was sighted in. By using additional stakes (A, fig. 27) or a horizontal board or log (B, fig. 27), the individual can align the weapon for grazing fire along more than one line or to cover an entire sector depending on the terrain.

- (2) *Grenade launchers.* Preplanned high angle fire can be delivered with grenade launchers by using the field expedient shown in C, figure 27. Short stakes are driven into the ground to control lateral movement of the weapon. Against these deflection stakes, two additional stakes are emplaced for elevation. A slight depression is scooped out for the toe of the weapon stock and an additional stake driven into it to absorb the recoil and prevent it from digging into the ground when fired. The weapon at no time touches the firer's shoulder.

#### 44. Fire Control

During periods of limited visibility, fire control is difficult to the extreme. The squad leader cannot see (except in his immediate vicinity) his men, the terrain, or the enemy. Normally, the enemy is so close to the squad's position before becoming visible that there is not time for the squad leader's decision as to where and when to fire. In addition, many of the daylight methods of fire control cannot be used. Therefore, special techniques must be developed for controlling squad fire.

*a. Opening Fire.* Each squad member opens fire *without command* when he *sees* an appropriate target. Team leaders and riflemen do not fire at noises or muzzle flashes unless ordered to do so by the squad leader. They fire only at observed enemy personnel. Such targets need not be clearly defined; however, they should be able to distinguish the target well

enough to allow proper weapon alignment. Automatic riflemen and grenadiers open fire *without command* on enemy automatic weapons or on observed personnel. All squad members deliver preplanned fire on order.

*b. Distributing Fire.* The enemy normally assaults in a line formation to get maximum fire to the front. With each rifleman and team leader searching his sector and opening fire when an enemy appears or when ordered to deliver preplanned fires, fire distribution against a linear formation is automatically achieved.

*c. Shifting and Concentrating Fire.* If the enemy assault hits only certain portions of the squad front, the squad members must shift their fires to these areas. By applying the following techniques, the squad can shift and concentrate its fire as needed and still maintain continuous surveillance of the entire sector.

- (1) The squad members who observe no enemy in their own sectors during an attack should check adjacent sectors. If they observe targets there, they shift their fire to these targets.
- (2) When delivering fire in adjacent sectors, they fire no more than two or three rounds, then shift back and check their own sector. If there are no targets in their own sector, they again shift and concentrate their fire in the same manner.

*d. Ceasing Fire.* When visibility is such that targets can be detected, the squad members cease fire without command when they no longer see appropriate targets. When the squad members are delivering preplanned fires, they cease fire on command.

#### 45. Ammunition Conservation

Proper application of fire and fire control automatically conserves ammunition. Proper application of fire insures that squad members fire only at visible targets appropriate for their weapons or deliver preplanned fires on order. By applying techniques that insure good fire control, fire will be initiated only when appropriate targets appear or when preplanned fires are ordered.

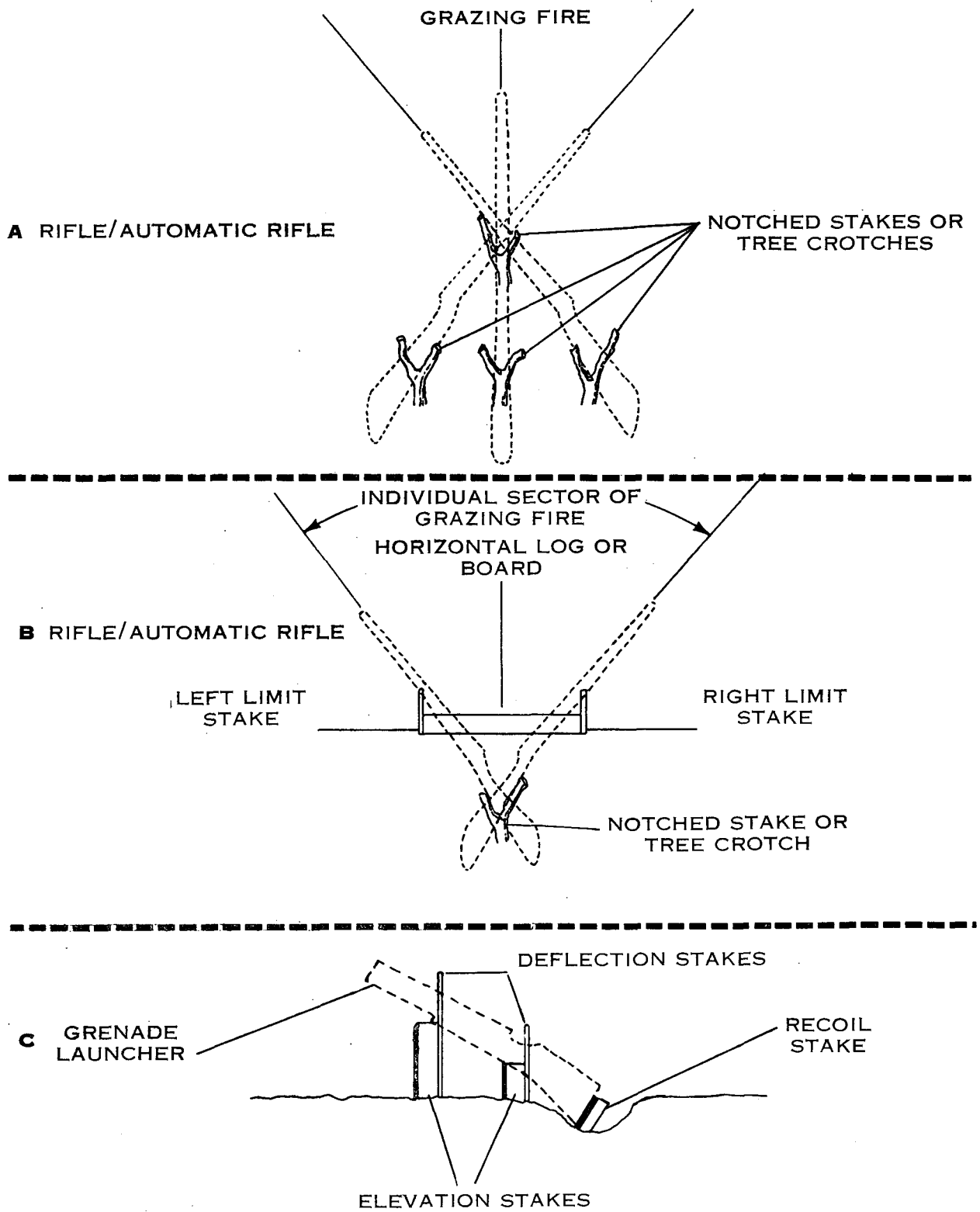


Figure 27. Field expedients for delivery of preplanned fires.

## 46. Control by the Squad Leader

The special techniques discussed herein for applying and controlling fires during periods of limited visibility will greatly assist the squad leader in his job of fire control. However, he must continually supervise to insure the tech-

niques are being applied properly. During a fire fight, he must move to a position where he can best influence the action, exerting his leadership in every way possible. When necessary, he supplements the techniques of applying and controlling fire with appropriate orders.

### Section III. SQUAD DEFENSIVE NIGHT FIRING INSTRUCTION

## 47. General

This section describes methods of training to develop and maintain proficiency in the fundamentals of squad defensive night firing to include the organization and operation of required range facilities. The training is presented in two phases: the Day Instruction Phase; and the Night Application Phase.

*a. The Day Instruction Phase* consists of a conference and practical exercises. During the conference, the squads are taught the fundamentals as described in paragraphs 41 through 46. During the practical work, the squads conduct a series of closely supervised live fire exercises.

*b. The Night Application Phase* is presented the evening of the same day the instruction phase is conducted if possible. During this phase, the fundamentals and techniques taught during the instruction phase are applied in a realistic live fire night defensive exercise.

## 48. Range Facilities

*a. General.* Squad defensive night firing ranges are organized to make maximum use of available training time by including facilities for concurrent training. Figure 28 shows a schematic diagram of a squad defensive night firing range.

*b. Firing Range.* The range should be constructed on fairly level terrain that enables the squad to deliver grazing fire out to the 40-meter bank of targets. It should be approximately 100 meters square and allow for a 130° small arms firing fan. Devices are used to represent realistic enemy action and battlefield noises.

- (1) *The firing line* should be no more than 40 meters in width to permit close supervision during instruction firing.

One-man foxholes are used so the actions of individuals can be easily observed and critiqued. Aiming stakes of the type described in paragraph 43b should be placed in front of each foxhole. These stakes must be placed so the squad members can get grazing fire out to the 40-meter bank of targets.

- (2) *Assaulting enemy personnel* are represented by pop-up E type silhouettes which are mounted on either manually or electrically operated target devices (figs. 97 and 98). These targets are placed in banks at 20 and 40 meters as shown in figure 28.
- (3) *Enemy automatic weapons* are represented by flashing red lights in conjunction with a machinegun or machinegun simulator (fig. 99).
- (4) *Battle noises* are produced by playing a recording of appropriate sounds over loudspeakers in pits down range. Battle noises can also be simulated by such means as placing tin cans down range and activating them with a length of rope or wire.
- (5) *Control* of all devices is centered at a range control point. From this point, devices are controlled with electrical switches and/or telephone communication to the target operators.

## 49. Day Instruction Firing

*a. Purpose.* These exercises provide training in the techniques of engaging visible targets during periods of limited visibility. They are conducted during daylight so errors can be observed and corrected.

*b. Conduct of Firing.* Immediately following the conference portion of the instruction phase,

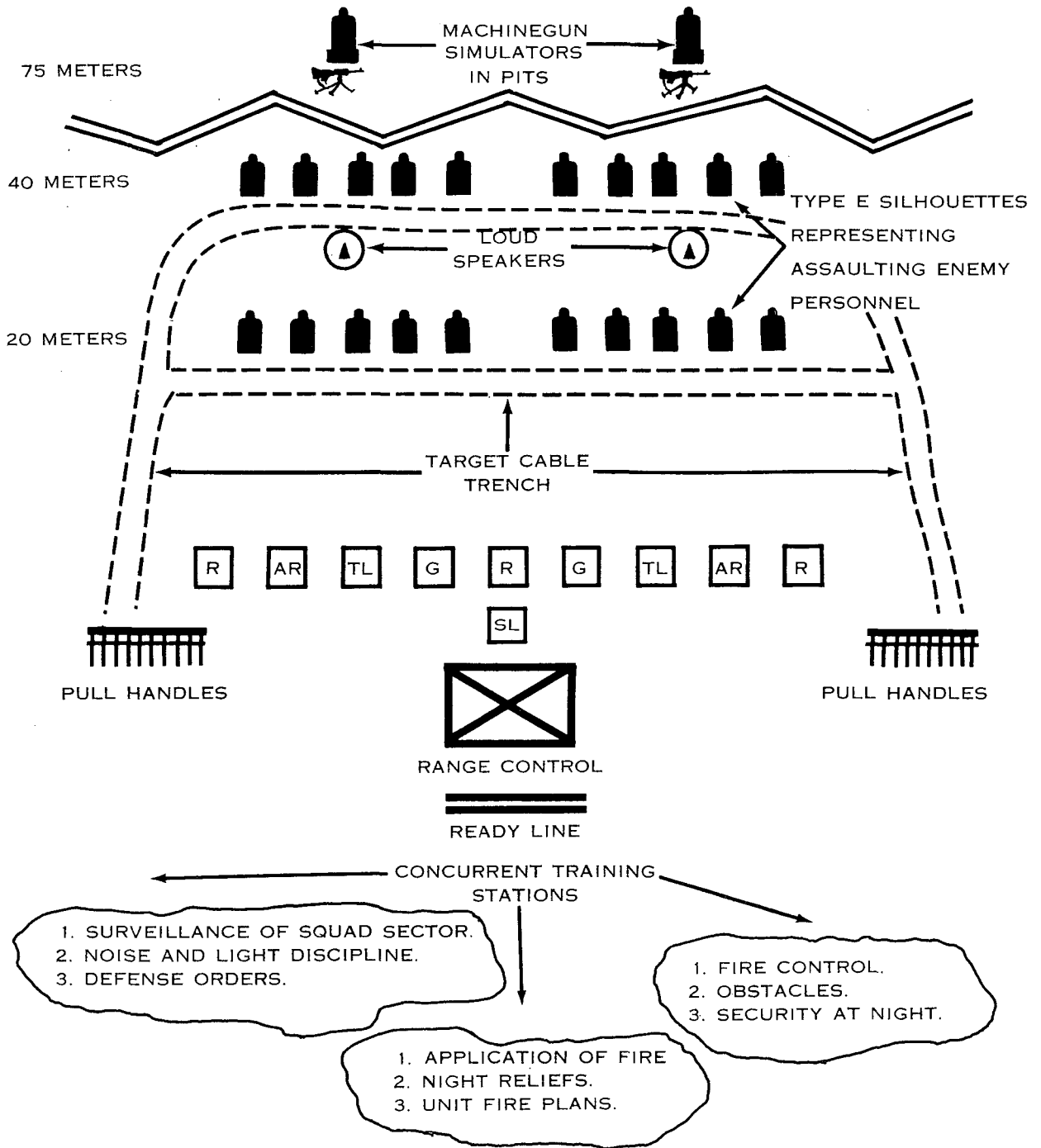


Figure 28. Squad defensive night firing range.

the squad is moved into foxholes and squad members are assigned a sector of surveillance. Each team leader and rifleman is issued one magazine of eight rounds of ball ammunition, automatic riflemen one magazine of 20 rounds of ball ammunition, and the grenadiers three rounds of practice ammunition. (See app. III for special safety precautions for the grenade launcher.) Squad members are reminded that these exercises are conducted using night firing techniques and that the white circle painted or chalked on certain silhouettes represents the muzzle flashes of enemy automatic weapons (figs. 28 and 99). The squad members load their weapons on order and the squad is placed under control of the squad leader.

- (1) Various combinations of targets are presented in a sequence representing an enemy assault supported by enemy automatic weapons firing on the squad's position.
- (2) The targets representing assaulting enemy personnel must be raised and lowered in distinct groups in the left or right portion of the squad sector, requiring squad members to shift and concentrate their fires.
- (3) The targets representing enemy automatic weapons must be activated twice during each exercise. Initially, they are activated at a time when all of the assaulting enemy personnel targets are down to test the squad members on their knowledge of the fundamental of application of fire (enemy automatic weapons are engaged by automatic riflemen and grenadiers only). They are then activated while the squad members are engaging the assaulting enemy personnel targets to cause the automatic riflemen and grenadiers to shift fire from their secondary targets (assaulting enemy personnel) to their primary target (enemy automatic weapons).
- (4) A typical target sequence is as follows:
  - (a) The left (right) half (five targets) of the 40-meter bank of targets (fig.

28) is raised, left up for 10 seconds, then lowered.

- (b) The enemy automatic weapon simulators are activated for ten seconds.
  - (c) The right (left) half (five targets) of the 40-meter bank of targets is raised, left up for 10 seconds, then lowered.
  - (d) The right (left) half (five targets) of the 20-meter bank of targets is raised. The enemy automatic weapon simulators are activated at the same time. The 20-meter bank of targets is lowered after it has been up 10 seconds. The simulators are activated for five seconds after the 20-meter bank of targets is lowered.
  - (e) The right (left) half (five targets) of the 40-meter bank of targets is raised, left up for 10 seconds, then lowered.
  - (f) The left (right) half (five targets) of the 20-meter bank of targets is raised, left up for 10 seconds, then lowered.
- (5) If at any time during an exercise it becomes obvious that too many errors are being committed, the exercise is stopped and corrections are made. At the completion of each exercise, the weapons are cleared and the squad is critiqued (par. 50).
  - (6) Each squad fires a minimum of three exercises, each of which is presented in a different target sequence.

*c. Safety Precautions.* The safety precautions for squad defensive night firing are covered in appendix III.

## 50. Instruction Firing Critiques

Immediately following each exercise, the squad members are critiqued. They remain in their foxholes for the critique. During instruction firing, the emphasis is entirely on teaching the squad members to apply the fundamentals of squad defensive night firing. Although the targets are not scored, the squad members are critiqued on the use of the pointing technique. Points that should be emphasized during the critique are as follows:



a. *Surveillance.* Squad members may fail to make definite checks on their flanks to insure continuous contact along the squad front and between squads (par. 42a and fig. 25).

b. *Application of Fire.* Riflemen will sometimes fire on the enemy automatic weapon targets. They must be reminded that individual rifle fire is relatively ineffective against such targets (par. 43). The automatic riflemen and grenadiers may engage assaulting enemy personnel while enemy automatic weapons are firing. In combat, the automatic riflemen and grenadiers will fire on individual riflemen if they present a greater threat. However, in training this is not done in order to stress the fundamental of application of fire.

c. *Fire Control.* Squad members may fail to shift and concentrate fire when there are no targets in their sectors. When they begin shifting and concentrating their fire, they have a tendency to neglect their sector (par. 44c).

d. *Ammunition Conservation.* It is difficult to critique the squad on this fundamental.

However, it should be stressed that the proper application of the other fundamentals will insure proper ammunition conservation (par. 45).

## 51. Night Application Firing Exercises

a. *Purpose and Scope.* The purpose of the application firing exercises is to test the squad's ability to apply the techniques learned during the instruction phase.

b. *Concurrent and Integrated Training.* By organizing the range as shown in figure 29, squad tactical training can be integrated into the live fire exercises and concurrent training can be conducted. In the concurrent training area (fig. 29), the squads review such subjects as night movement and the fundamentals of squad defensive night firing. Just prior to conducting its live fire exercise, the squad is sent to the tactical assembly area. In this area the squad receives instruction and practice in the actions of the squad in an assembly area. This tactical training then becomes a part of the exercise.

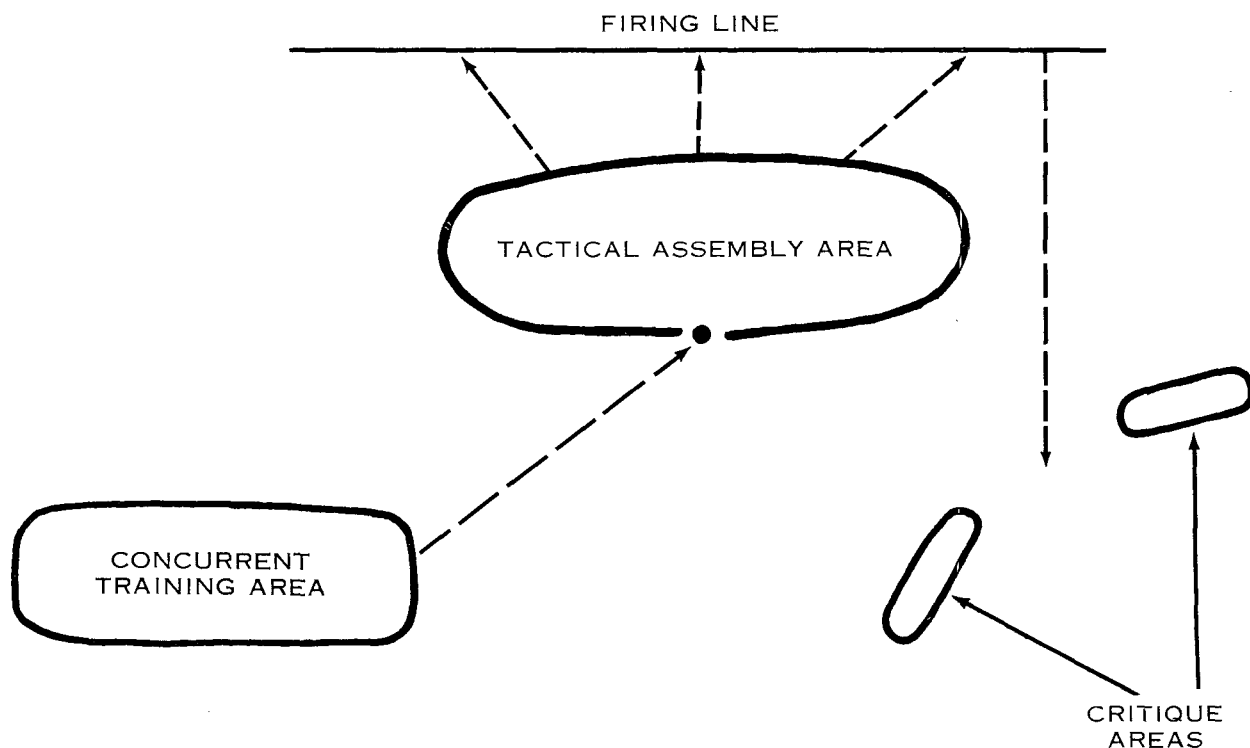


Figure 29. Concurrent training area—night application firing.

*c. Conduct of Training.*

- (1) For best results, it is advisable to conduct this training when there is less than a quarter-moon.
- (2) In order to preserve night vision, red-filtered lights should be used for marking safety limits, scoring, and other lighting requirements.
- (3) After it is dark enough to start training, the safety regulations and fundamentals are reviewed. Following this review, the squad to fire first is moved to the tactical assembly area, and the remaining squads are moved to the concurrent training area.
- (4) Starting with the squad in the tactical assembly area, each squad fires one application firing exercise in the following sequence:
  - (a) The squad moves tactically from the assembly area into the foxholes and is issued its ammunition. Team leaders and riflemen are issued six magazines containing five rounds of ball ammunition each. Automatic riflemen receive four magazines containing 20 rounds of ball ammunition each, and grenadiers ten practice rounds each. See appendix III for special safety precautions for the grenade launcher.
  - (b) The enemy automatic weapons simulators are activated and the squad members are told that the blinking red lights represent the muzzle flashes of enemy automatic weapons. On order, the automatic riflemen load and fire one magazine at the enemy automatic weapon simulators for familiarization with the field expedient night sight. On order, the automatic riflemen reload, and the remainder of the squad loads. The squad is then placed under the control of the squad leader.
  - (c) Before any targets are exposed, battle noises are played to test the squad's fire discipline.
  - (d) After the squad's fire discipline has been tested, the 20-meter bank of targets is activated as described in

paragraph 49b (instruction firing), and squad members engage visible targets using appropriate techniques.

- (e) Just prior to ending each exercise, all targets are lowered and the recording of battle noises or noise makers continues for a brief period to test the squad's fire discipline. After the squad's fire discipline has been tested, the squad leader orders the squad to deliver preplanned fires. While the squad is delivering preplanned fires, the 40-meter bank of targets is raised and left in the up position until the squad is ordered to cease fire.
- (f) After the squad completes its exercise, the weapons are cleared and the squad is moved to a critique area.

## **52. Critique and Scoring of Night Application Firing**

*a. Critique.* Each squad is critiqued and shown its score immediately following its exercise. The critique must be held in an area sufficiently removed from the firing line to eliminate distractions. It is conducted by the Safety Officer or NCO who supervised the squad's firing. A critique chart similar to the one shown in figure 82 should be used.

*b. Scoring.* Figure 81 depicts a type of score chart that can be used to show the squad the effectiveness of its fire. A schematic drawing of the target arrangements will help to show the squad which targets were hit, how well the squad members shifted and concentrated their fire, and how effective their preplanned fires were. The scoring system used must give credit for accuracy, distribution, and concentration of fire. For example, five points may be given for each silhouette hit (distribution score) plus one point for each hit in any silhouette (accuracy and concentration score). It must be emphasized that the number of hits on the 20-meter bank of targets is not only an indication of how well the individual squad members detect and fire on targets in their sectors, it also shows how well they shifted and concentrated their fire in adjacent sectors.

## Section IV. SQUAD DEFENSIVE NIGHT FIRING PROFICIENCY COURSE

### 53. General

In order to maintain proficiency, squads must be required to conduct training periodically in squad defensive night firing. This training will also enable the unit commander to evaluate his squads and determine the need for additional training in this subject.

### 54. Range Facilities

The range for proficiency firing can be the same as that used during the initial training in squad defensive night firing (fig. 28). However, at this level of training and experience the range should include more devices and have more distance between foxholes to provide a more realistic tactical situation.

### 55. Proficiency Training

*a. Conduct of Firing.* The firing is conducted in the same manner as the application firing exercise described in paragraph 51c. A brief review of the fundamentals of squad defensive night firing should be conducted prior to the exercise. The firing should be integrated into a tactical exercise.

*b. Critique.* The squad is critiqued on the fundamentals in the same manner as in the application exercise (par. 52a).

*c. Scoring.* Scoring is based on the squad's application of the fundamentals as well as hits. For example, each squad can be given 100

points to begin with for scoring its performance of the fundamentals. During the exercise the squad is observed and points subtracted, depending on the proficiency displayed. The squad's hit and distribution score is figured separately. Both scores (fundamental score and hit and distribution score) are then compared to those made by other squads to determine the squad's proficiency. This will indicate to a commander which squads are below average and the specific areas in which further training is needed.

(1) *Application of fundamentals score.*

(a) *Surveillance of the squad sector:*  
Total Possible Points— 20

(b) *Application of fire:*  
Total Possible Points— 30

(c) *Fire control:*  
Opening fire-----8  
Distributing fire----8  
Shifting fire-----8  
Concentrating fire\_\_8  
Ceasing fire-----8  
Total Possible Points— 40

(d) *Ammunition conservation:*  
Total Possible Points— 10

-----  
Total Possible Points—100

(2) *Hit and distribution score:* -----  
(Determined by using the scoring system recommended in paragraph 52b.)

## Section V. FUNDAMENTALS OF SQUAD ASSAULT NIGHT FIRING

### 56. General

*a.* The squad will encounter several difficulties while assaulting during periods of limited visibility.

- (1) Normally, sights cannot be used.
- (2) It is difficult to move fast while maintaining alinement.
- (3) It is difficult for the squad members to reload their weapons.
- (4) The squad members have a tendency to fire high.
- (5) The squad members can easily lose their sense of direction and become disorganized.

(6) It is difficult to apply fires properly while moving.

*b.* In order to overcome these difficulties and assault successfully during periods of limited visibility, the squad members must apply special techniques to insure that they—

- (1) Can deliver fire effectively without the use of the sights on their weapons.
- (2) Move rapidly and maintain alinement so all squad members will arrive on the objective in the shortest possible time.
- (3) Reload rapidly to prevent lulls in the firing.

- (4) Keep the fire down in the objective area in order to get the maximum effect from their fire.
- (5) Distribute fire so all enemy positions on the objective are covered.

## 57. Firing Position

*a.* The team leaders, riflemen, and automatic riflemen use the underarm firing position during the night assault (fig. 30). In training, team leaders and riflemen are taught to fire one round every time the left foot strikes the ground. (Left-handed men fire every time the right foot strikes the ground.) Automatic riflemen are taught to fire a short burst (two or three rounds) every time the left foot strikes the ground. In combat, it may not be possible to fire this often. However, they should attempt to fire as often as possible as the appropriate foot strikes the ground.

*b.* The grenadiers fire, using the pointing technique (fig. 31) and as rapidly as possible.

## 58. Speed of Movement and Maintaining Alinement

The squad must move rapidly and maintain alinement to reach the objective in mass in the shortest possible time. To accomplish this, the following techniques are used:

*a.* The squad moves as rapidly as possible consistent with its ability to fire accurately and maintain alinement.

*b.* A base man is designated in each squad. All other squad members guide on the base man. By controlling the speed of the base man, the squad leader can adjust the speed and direction of the squad. In the case of a center squad (normally the base squad in a platoon), a center rifleman is used as a base man. Flank squads use riflemen on the flank nearest the base squad as the base men.

*c.* Visual contact is maintained between all squad members. The interval between squad members is determined by the degree of visibility. On a bright night, the squad leader establishes a set interval to prevent squad members from being spread out too far. Under no circumstances should the interval exceed 10 meters.

*d.* The squad members maintain alinement by visual contact and sensing the muzzle flashes to their flanks.

*e.* Squad members must not stop during the assault. Stopping disrupts alinement and slows down the speed of movement.

## 59. Reloading

The squad members must learn to reload rapidly to avoid lulls in the firing. Rapid reloading is achieved by practice and by applying the following techniques:

*a.* Prior to the assault, squad members check their ammunition to be sure it is clean and serviceable. Magazines are inspected to insure they are clean and will work in the magazine recess.

*b.* Ammunition is carried in a manner which will permit rapid reloading. All ammunition pouches are cleared of any material which may interfere with the handling of magazines. Flaps on ammunition pouches are folded back and the magazines are placed in the pouches for easy insertion in the magazine recess. When bandoleers are used to carry ammunition, all wrappings are removed.

*c.* Squad members must retain their empty magazines. This can be accomplished by either placing them inside their jackets, an empty sandbag, or other container attached to their belts.

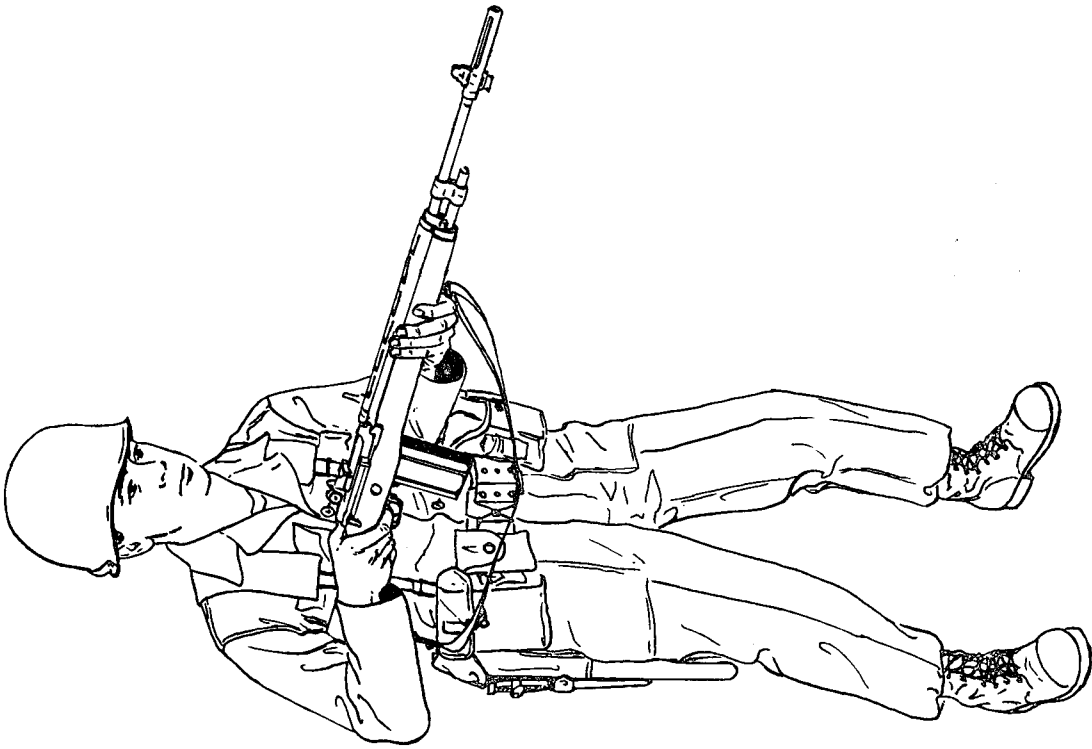
*d.* Grenadiers remove the plastic protective cups from the grenades and carry them loose in the ammunition pouches.

## 60. Keeping the Fire Down

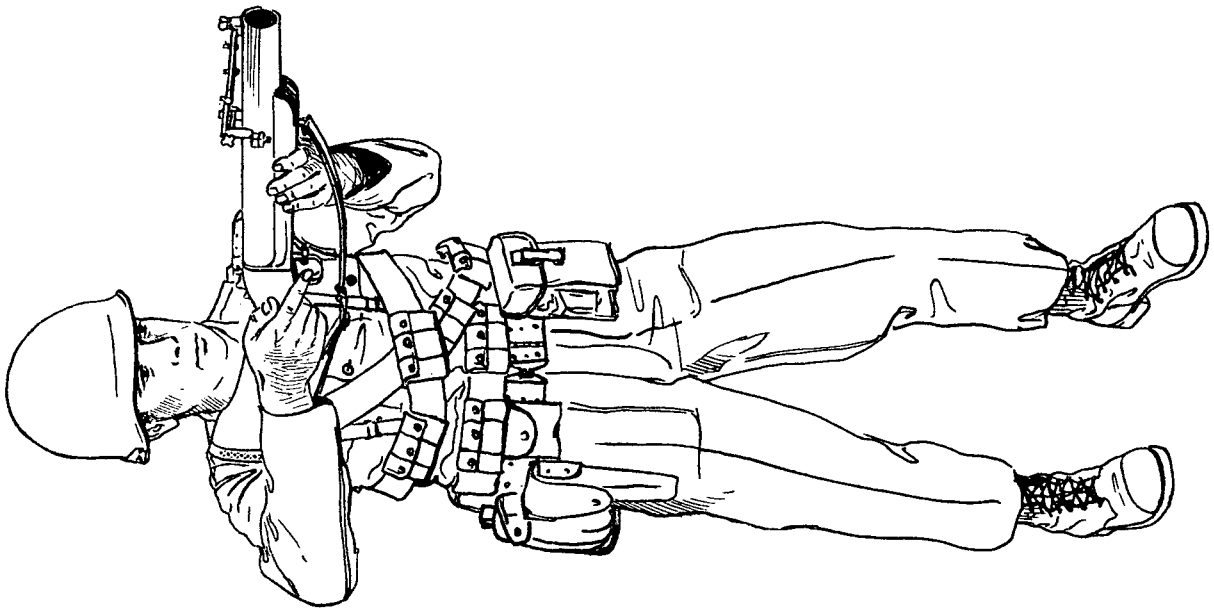
The squad members have a tendency to fire high. This can be overcome by—

*a.* Making the squad members aware of the tendency to fire high and instructing them to make an initial bold depression of the muzzles of their weapons.

*b.* Using tracer ammunition to adjust their fire. In addition to providing a means of adjusting the fire, tracer ammunition illuminates the objective area, helps the squad members to detect targets, and has a demoralizing effect on the enemy.



*Figure 30. The underarm firing position.*



*Figure 31. The standing position using the pointing technique.*

## 61. Distributing Fire

To insure that fire is properly distributed over the objective area, the following techniques are applied:

a. Team leaders and riflemen fire on that portion of the objective corresponding to their position in the squad. If there are no targets in their sectors, they may fire as far to the left and right as safety permits in order to concentrate fire on known or suspected enemy positions.

b. Automatic riflemen fire on as much of the objective area as possible without endangering other squad members, giving priority to enemy automatic weapons.

c. Grenadiers distribute fire on that half of the objective area corresponding to their position in the squad.

d. Normally, the squad leader does not fire. His primary concern is controlling his squad.

## Section VI. SQUAD ASSAULT NIGHT FIRING INSTRUCTION

### 62. General

Squad assault night firing instruction consists of two phases: the Instruction Phase and the Application Phase, both of which are presented in one night. This instruction should closely follow squad defensive night firing instruction.

a. *The Instruction Phase* consists of a conference and a series of practical exercises. During the conference, the squads are taught the techniques described in paragraphs 56 through 61. The practical work consists of a series of closely supervised exercises in which these techniques are stressed.

b. *The Application Phase* is a live fire exercise which requires the squads to apply what they learned during the instruction phase.

### 63. Range Facilities

a. *General Characteristics.* Figure 32 shows a schematic diagram of a squad assault night firing range. The range should be constructed on relatively level, cleared terrain approximately 100 meters square. The range has a starting line with individual starting points 5 meters apart. The individual starting points are marked by white stakes. The firing line is an administrative line located 5 meters forward of the starting line. The cease fire line is located 60 meters forward of the starting line and is marked by a single red light on each flank of the range. The objective area is 70 meters forward of the starting line. The target devices on the objective consist of a 10 F type silhouettes mounted on wooden stakes which

are placed in canisters as shown in figure 100. Each silhouette is covered or painted with a reflective surface and has a red light mounted at its base (fig. 100). When these lights are turned on and off, the light reflected off the surface of the silhouettes simulates enemy fire.

b. *Concurrent Training Areas.* Concurrent training areas are organized as shown in figure 33.

### 64. Instruction Firing Exercises

a. *Purpose.* Instruction firing exercises are designed to give the squads practical work in night assault firing techniques.

b. *Types of Exercises.* Three types of exercises are conducted in the following sequence:

- (1) *Dry firing exercises.* In these exercises, the squads are deployed in a line formation and practice using the proper firing positions, moving rapidly, and maintaining alinement. This training can be conducted on any relatively flat, cleared area. A squad should be capable of moving from the starting line to the cease fire line (approx. 60 meters) in about 30 seconds while maintaining its alinement.
- (2) *Ball ammunition exercises.* These exercises provide training in reloading as well as further practice in firing positions, moving rapidly, and maintaining alinement. Ball ammunition is used instead of tracer so the squad members will concentrate on reloading rather than where their fire is going. The squad is deployed on the

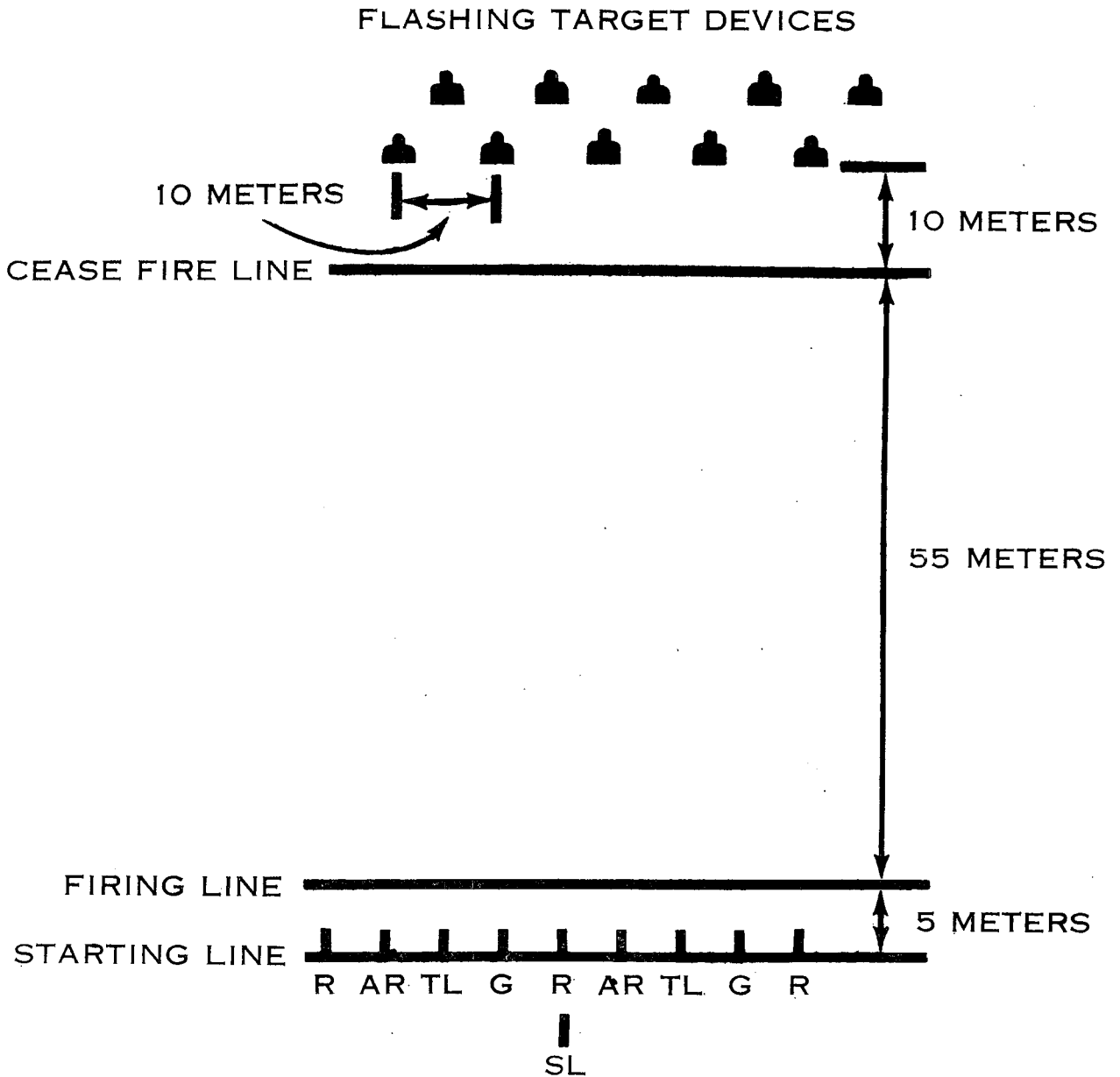


Figure 32. Squad assault night firing range.

starting line and issued ammunition. Team leaders and riflemen are issued three magazines containing eight rounds each, automatic riflemen receive three magazines containing 20 rounds each. Each grenadier is issued three rounds of practice ammunition. See appendix III for special safety precautions for the grenade launcher.

(3) *Tracer ammunition exercises.* These exercises integrate training in all the techniques with emphasis on keeping the fire down and fire distribution, and are conducted in the same manner as the ball ammunition exercises except tracer is used instead of ball ammunition.



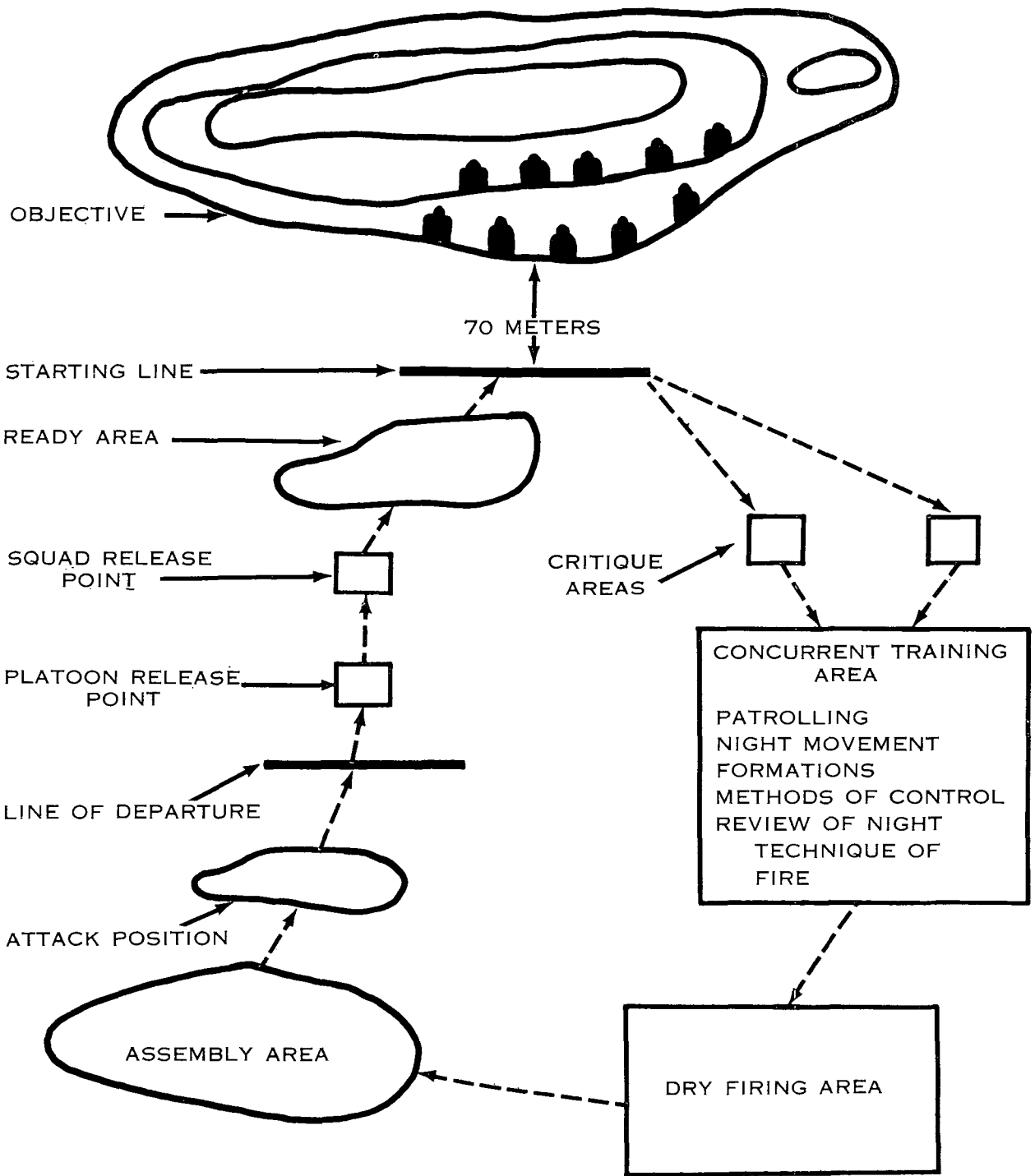


Figure 33. Concurrent training areas for squad assault night firing range.

*c. Conduct of Live Fire Exercises.* The live fire exercises are conducted in the following sequence:

- (1) A Safety NCO is stationed at each starting point. (The nature of this training requires a Safety NCO to accompany each firer to insure that safety precautions are being followed.)
- (2) On order, the squad moves to the starting line.
- (3) On order, the Safety NCO's issue ammunition and the squad members lock and load their weapons.
- (4) Each Safety NCO reports in sequence when the squad member at his point has locked and loaded his weapon.
- (5) When all of the Safety NCO's have reported, the squad leader is instructed to begin the assault.
- (6) The squad leader then starts the assault by giving the command MOVE OUT.
- (7) When the squad has moved approximately 5 meters, the targets are activated and the squad leader gives the command COMMENCE FIRING.
- (8) The squad is halted at the cease fire line and instructed to lock and unload.
- (9) The weapons are then cleared by the Safety NCO's and unexpended ammunition is collected.
- (10) Each Safety NCO reports in sequence when the weapon at his point is clear.
- (11) The squad is then critiqued in place.

*d. Safety Precautions.* The safety precautions for squad assault night firing are covered in appendix III.

## 65. Instruction Firing Critiques

During the exercise, the Safety Officer observes closely to detect mistakes made by the squad members. When necessary, he halts the squad and makes on-the-spot corrections. The squad must not be permitted to practice mistakes. At the completion of each exercise, Safety NCO's critique the individual firers and the Safety Officer critiques the overall performance of the squad. Some of the more common mistakes are as follows:

*a. Firing Positions.* Some squad members may fail to fire when the appropriate foot strikes the ground.

*b. Speed of Movement and Maintenance of Alinement.* The squad members may have a tendency to move too slowly, or experience difficulty in maintaining alinement and proper intervals.

*c. Reloading.* The squad members may not carry ammunition in a manner to facilitate reloading or fail to save their magazines.

*d. Keeping the Fire Down.* The squad members may fail to make bold depressions of the muzzle of their weapons in order to get fire down in the objective.

*e. Fire Distribution.* Squad members, particularly the automatic riflemen, may have a tendency to confine their fire directly to their front.

## 66. Application Firing

*a. Purpose and Scope.* The purpose of the application firing exercise is to test the squad's ability to apply the techniques learned during the instruction phase. It is conducted in the same manner as the instruction firing tracer ammunition exercises.

*b. Concurrent Training.* To insure maximum use of training time, concurrent training is conducted while the squads are waiting to fire an exercise or after the exercise has been completed (fig. 33). Concurrent training should include further practice in the techniques of night assault firing and related subjects such as patrolling, night movement, methods of control, and squad formations.

*c. Integrated Training.* The application firing exercises should be conducted in a tactical setting which requires the squad to move through the control points of a night attack (fig. 33). (See paragraph 74 for a discussion of night attack control points.) Each squad starts the exercise in a tactical assembly area. An attack order is issued and the squad goes through the preparatory steps of a night attack as outlined in paragraph 91. The squad then moves tactically from the assembly area through all the control points of a night attack to the starting line or a ready area. During the

movement forward, the purpose of each control point is explained.

*d. Conduct of Firing.* On order, the squad moves from the ready area (fig. 33) to the starting line and fires the application exercise. Team leaders and riflemen are issued three magazines containing 10 rounds of tracer ammunition each. Automatic riflemen are issued three fully loaded magazines. Each grenadier receives three rounds of practice ammunition. (See app. III for special safety precautions for the grenade launcher.) At the completion of the exercise, the squad is moved to a critique area.

## 67. Critique and Scoring of the Application Firing Exercises

*a. Critique.* Immediately following the application firing exercises, the Safety Officer or

NCO who supervised the exercise conducts a critique. The critique areas are located so the firing will not interfere with the critique (fig. 33). The critique is conducted in the same manner as discussed in paragraph 65.

*b. Scoring.* The same procedure used for scoring in squad defensive night firing (par. 52) is recommended for these exercises. The score must not be overemphasized. The manner in which a squad applies the techniques is of more importance than accuracy. For example, the squad members can fire more accurately when they move slowly and fire from the shoulder than they can by using the correct techniques. However, using improper techniques such as these will seriously affect the squad's ability to move rapidly, maintain its alignment, and reload rapidly. Therefore, the score is valid only when a squad applies the correct techniques.

## Section VII. SQUAD ASSAULT NIGHT FIRING PROFICIENCY COURSE

### 68. General

In order to maintain proficiency, squads must be required to conduct training periodically in squad assault night firing. This training will also enable the commander to evaluate his squads and determine the need for additional training in this subject.

### 69. Range Facilities

The range facilities for the proficiency firing course are the same as those used in the instruction and application phases of squad assault night firing instruction (figs. 32 and 33).

### 70. Proficiency Firing

*a. Conduct of Firing.* The firing is conducted in the same manner as the application firing exercise described in paragraph 66d. A brief review of the fundamentals of squad assault night firing should be conducted prior to the exercise. The firing should be integrated into a tactical exercise.

*b. Critique.* The squad is critiqued in the same manner as the application phase of squad assault night firing instruction (par. 67).

*c. Scoring.* Scoring is based on the squad's application of the fundamentals as well as hits.

For example, each squad can be given 100 points to begin with for scoring its performance of the fundamentals. During the exercise, the squad is observed and points subtracted, depending on the proficiency displayed. The squad's hit and distribution score is figured separately. Both scores (application of fundamental score and hit and distribution score) are then compared to those made by other squads to determine its proficiency. This will indicate to a commander which squads are below average and the specific areas in which further training is needed.

#### (1) Application of fundamentals score:

##### (a) Firing positions:

Total Possible Points— 15

##### (b) Speed of movement and maintenance of alignment:

Total Possible Points— 20

##### (c) Reloading:

Total Possible Points— 25

##### (d) Keeping the fire down:

Total Possible Points— 20

##### (e) Distributing fire:

Total Possible Points— 20

Total Possible Points—100

(2) *Hits and distribution score:* -----  
(Determined by using the scoring  
system recommended in paragraph

52b. See figure 84 for a recommended  
score chart.)

## CHAPTER 5

### TACTICAL APPLICATION

---

#### Section I. INTRODUCTION

##### 71. General

In order to conduct realistic training as previously described in this manual, it is necessary to integrate technique of fire with basic squad tactics. FM 7-15 contains the tactical doctrine concerning the employment of the rifle squad. Tactics of the rifle squad are basically simple and are dependent on the ability of the squad members to move from one position to another, deploy, and properly apply and control their collective firepower.

##### 72. Scope

This chapter amplifies the doctrine contained in FM 7-15 to assist the instructor in the integration of technique of fire with squad tactics. This chapter includes—

- a. The definitions of terms commonly used in basic squad tactics.
- b. Squad formations.
- c. The more commonly used arm-and-hand signals.
- d. Working techniques for the tactical employment of the squad.

#### Section II. DEFINITIONS

##### 73. General

This section defines the more common terms used in squad tactical training. These terms must be understood by the squad members prior to receiving training in offensive and defensive tactics. The definitions of these terms are stated as they apply to the rifle squad.

##### 74. Attack Terms

a. *Fire and Maneuver*. A plan of attack consists of two basic parts: a *fire support plan*; and a *scheme of maneuver*. Fire and maneuver consists of an element(s) establishing a base of fire to cover the movement of another element(s) while it maneuvers to close with and destroy or capture the enemy.

b. *Fire and Movement*. When the maneuver element meets effective enemy opposition and can no longer advance under the cover of supporting fires, it employs fire and movement. Fire and movement consists of one element providing close fire support while another element advances toward the enemy. Fire and movement differs from fire and maneuver in that fire and movement is executed by the

*force(s) which will conduct the assault on the objective.*

c. *Assembly Area*. The area where a unit prepares for further action. Orders are issued and maintenance and resupply are accomplished to the extent permitted by the time available. In an attack situation, it is usually company size and located within one hour's movement time of the line of departure (figs. 34 and 35).

d. *Attack Position*. This is the last concealed and covered position short of the line of departure where platoons deploy in the attack formation, fix bayonets, and make final coordination. The platoon will halt in the attack position only when final preparations cannot be completed in the assembly area or on the move, or when ordered by the company commander (fig. 34).

e. *Line of Departure (LD)*. This is a line designated by the company commander to coordinate the beginning of the attack and is usually an easily recognizable terrain feature such as a stream or road, running perpendicular to the direction of attack (fig. 34).

f. *Phase Line (PL)*. This is a line running perpendicular to the direction of attack and is usually an easily recognizable terrain feature such as a ridge line, stream, or road. It is used by the company commander to control forward movement and as a reference in reporting locations. The squad stops at phase line only on order (fig. 35).

g. *Final Coordination Line*. This is a line used to coordinate the lifting and shifting of supporting fires and the final deployment of the maneuver element in preparation for conduct-

ing an assault against an enemy position. It is located as close to the enemy positions on the objective as attacking troops can move before becoming dangerously exposed to friendly supporting fires. It should be recognizable on the ground. Ideally, *it should have concealment and cover* (fig. 34).

h. *Objective*. This is a designated locality or terrain feature to be captured or reached during the attack or during movement (fig. 34).

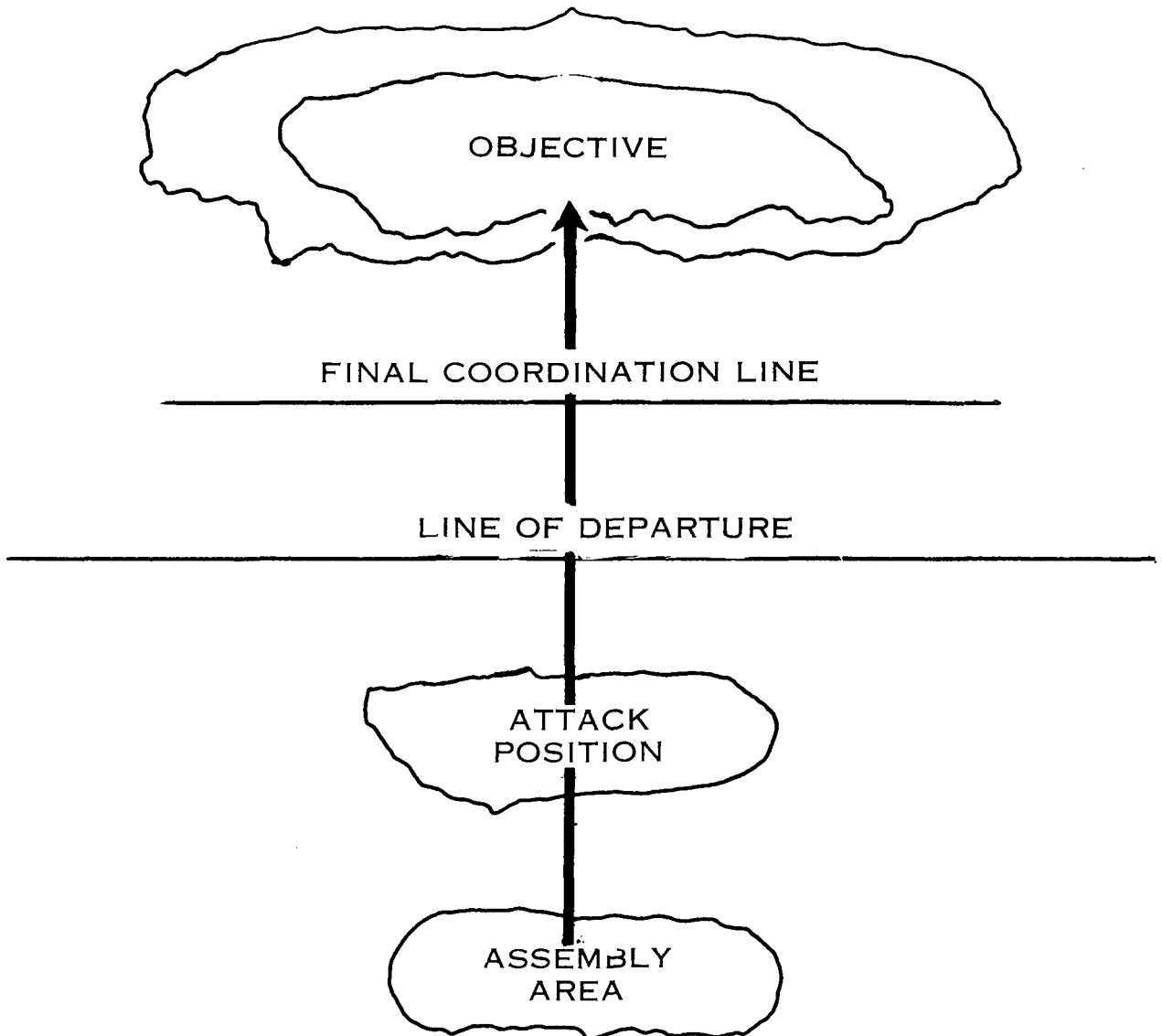


Figure 34. Control measures used during a daylight attack.

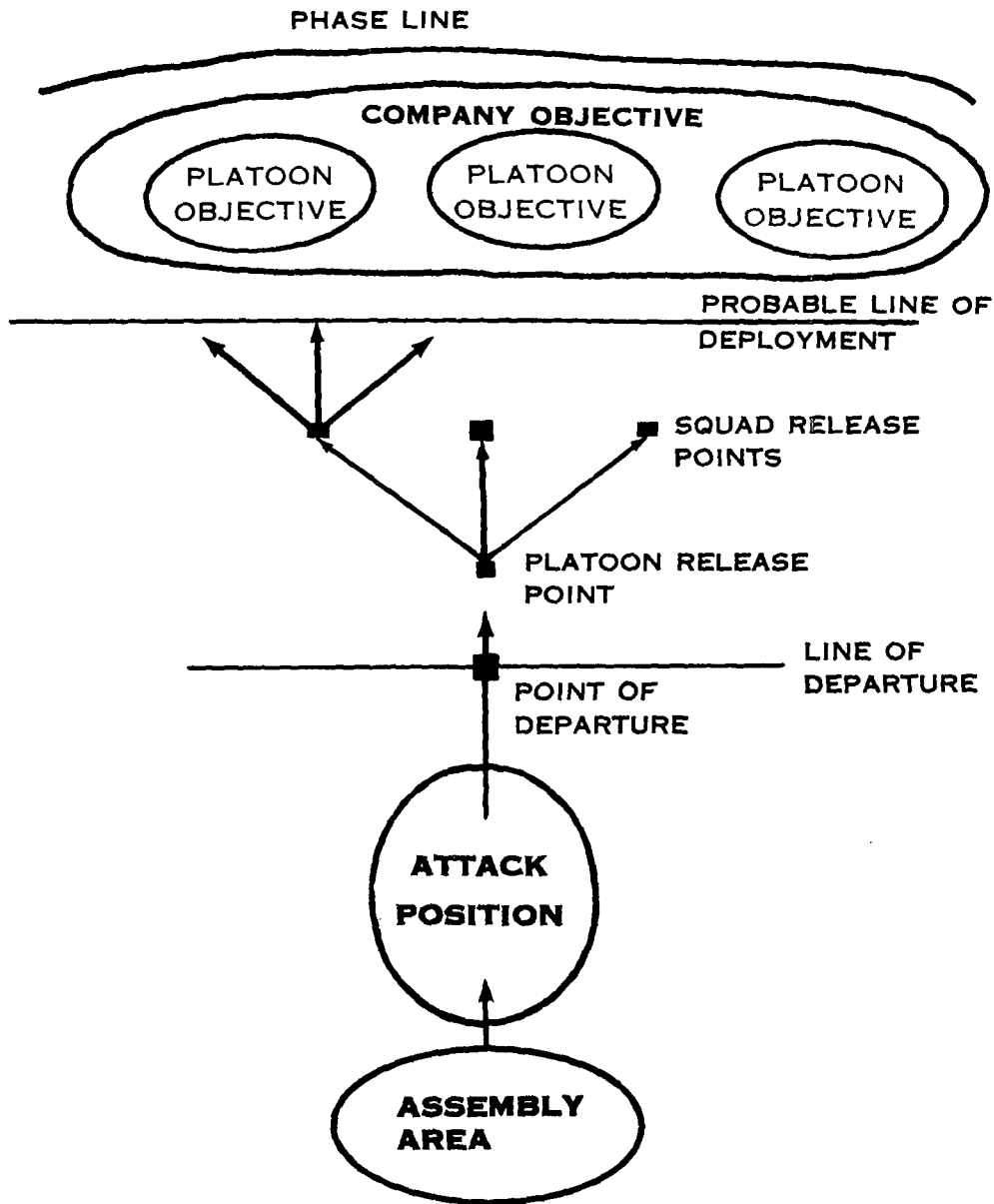


Figure 35. Control measures used during a night attack.

*i. Reorganization on the Objective.* Reorganizing the attacking unit as necessary by replacing casualties, reassigning men if necessary, ammunition resupply or redistribution as necessary, and performing any other actions necessary to prepare the unit for further action.

*j. Consolidation of the Objective.* Organizing and strengthening a newly captured position to defend against an enemy counterattack.

*k. Point(s) of Departure.* Specific locations at which designated units will cross the line of departure in a night attack (fig. 35).

*l. Release Points (RP).* A clearly defined point on a route where units are turned over to the control of their respective leaders (fig. 35).

*m. Probable Line of Deployment (PLD).* A line previously selected on the ground where

attacking units deploy in line formation prior to beginning a night assault. It is located as close to the objective as possible without revealing the presence of the assaulting elements (fig. 35).

## 75. Defense Terms

*a. Sector of Fire.* An area assigned to an individual or unit to be covered by fire (fig. 36).

*b. Principal Direction of Fire (PDF).* A direction of fire assigned to a weapon (in the rifle squad to automatic riflemen and grenadiers) which takes priority over targets which may appear elsewhere in the squad sector. A PDF may be assigned to cover a likely avenue of approach or to mutually support adjacent units.

*c. Long Range Fires.* Fires employed against the enemy as soon as he comes within effective range.

*d. Close Defensive Fires.* Fires employed against the enemy that subject him to an increasingly heavier volume of fire as he approaches the battle area.

*e. Final Protective Fires.* Fires immediately

in front of the battle area which are used to break up the enemy assault.

*f. Forward Edge of the Battle Area (FEBA).* The FEBA is the line formed by the forward defensive positions (fig. 36).

*g. Frontage.* Space from side to side covered by a unit in combat. The squad frontage will vary from approximately 30 meters in unfavorable terrain to 100 meters in favorable terrain. The distance between two-man foxholes should not exceed 20 meters in open terrain. For single foxholes, the figure is halved.

*h. Primary Position.* That location on the ground which provides the best observation and fields of fire to accomplish the assigned mission (fig. 36).

*i. Alternate Position.* This is normally the second best position in the vicinity from which the original mission can be accomplished.

*j. Supplementary Position.* A position assigned to a unit for defending in a direction that cannot be covered from the primary position (fig. 36).

*k. Listening and Observation Posts.* Positions from which individuals listen for or observe and report enemy activity; a security measure (fig. 36).

## Section III. SQUAD FORMATIONS

### 76. General

*a.* The rifle squad combat formations are the squad file (fig. 37), squad column (figs. 38 and 39), and squad line (fig. 40). The squad column is the basic formation from which the others are derived.

*b.* When moving as part of the platoon, the initial squad combat formations may be selected by the platoon leader. The squad leader may alter his formation to meet changes in the situation and terrain.

*c.* The squad leader places himself within the formation where he can best exercise control. The fire team leaders place themselves in the designated formations as directed by the squad leader. Other members of the squad take their appropriate positions based on the location of the fire team leader or as he directs.

*d.* The squad leader controls the squad by oral commands, audible signals, arm-and-hand signals, and through his fire team leaders.

*e.* The squad maintains observation to the front, rear, and flanks. While moving or halted, squad members are responsible for observing in definite directions.

*f.* The distance between men vary within a formation, depending on visibility and terrain. While maximum dispersion is desirable to reduce vulnerability to direct and indirect fires, effective control must be maintained. When visibility is good, formations are more dispersed. During conditions of limited visibility or in close terrain, distances between men are reduced.

*g.* In selecting or modifying squad formations to conform to a particular situation or because of reduced strength, the following fundamentals apply:



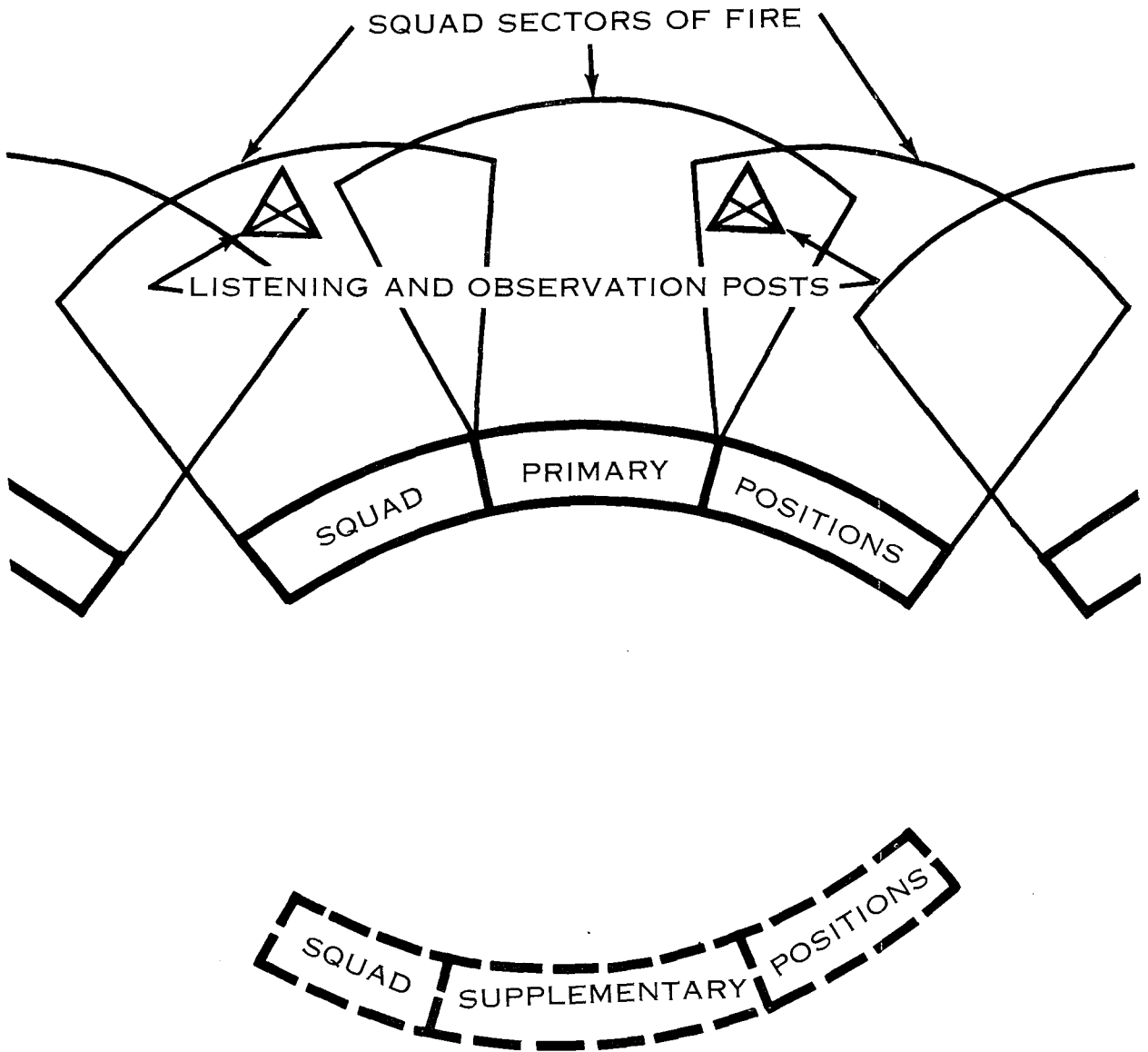
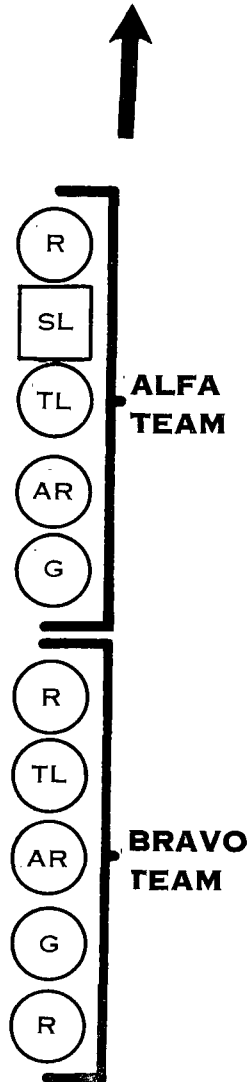


Figure 36. Defensive positions.

1. LIMITED FIREPOWER TO FRONT AND REAR.
2. MAXIMUM FIRE POWER TO FLANKS.
3. FACILITATES CONTROL AND MOVEMENT.
4. COMMONLY USED IN DENSE TERRAIN AND DURING PERIODS OF LIMITED VISIBILITY WHEN SPEED AND CONTROL ARE ESSENTIAL.



*Figure 97. Squad file, ALFA team leading.*

1. ALL-AROUND SECURITY.
2. FACILITATES CONTROL.
3. FACILITATES BATTLE DRILL.

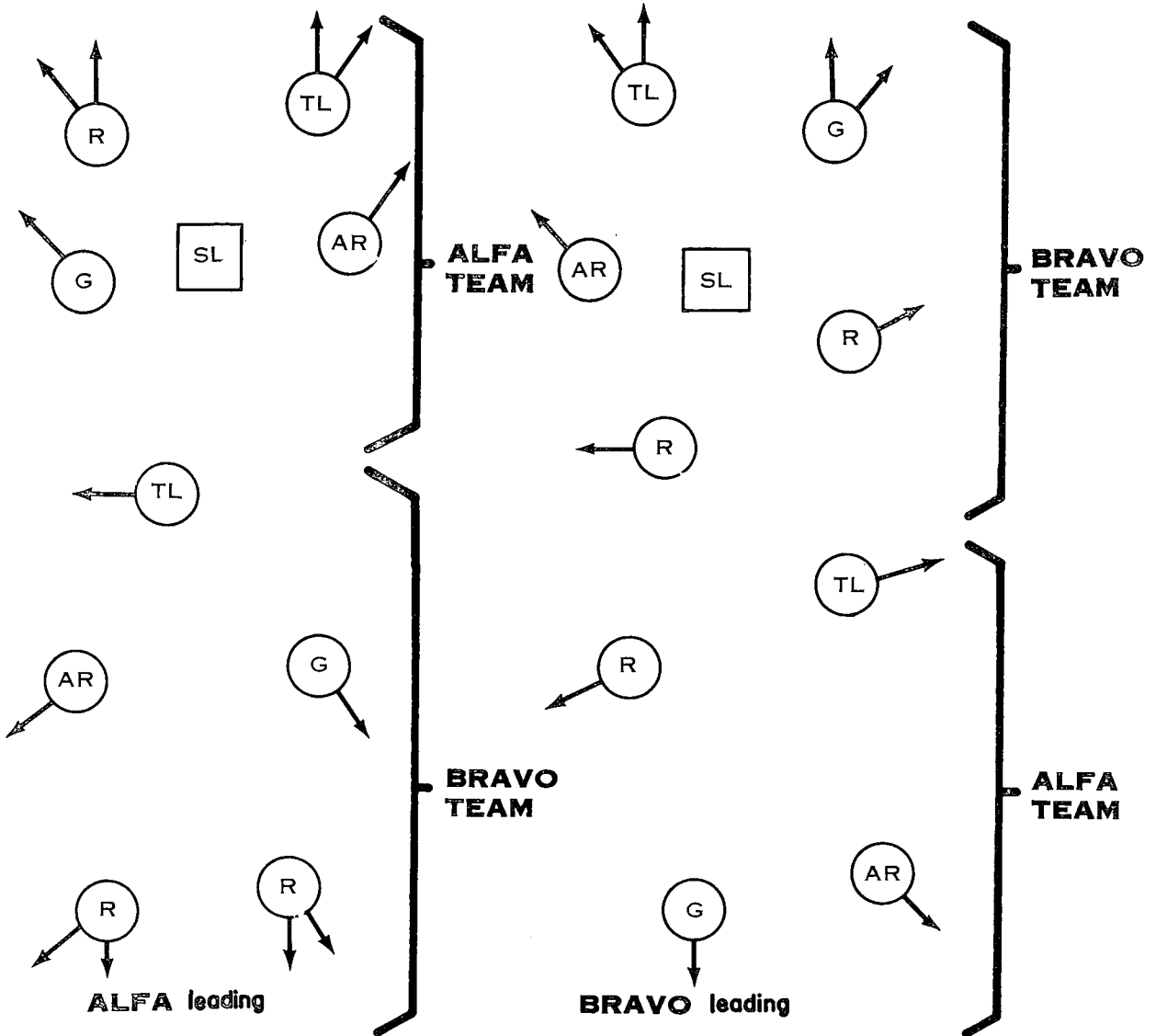


Figure 38. Squad column, fire teams in column.

1. ALL-AROUND SECURITY
2. INCREASED DISPERSION

1. ALL-AROUND SECURITY.
2. FACILITATES DEPLOYMENT ON ROAD.
3. USED MOST FREQUENTLY ON ROAD OR TRAIL.

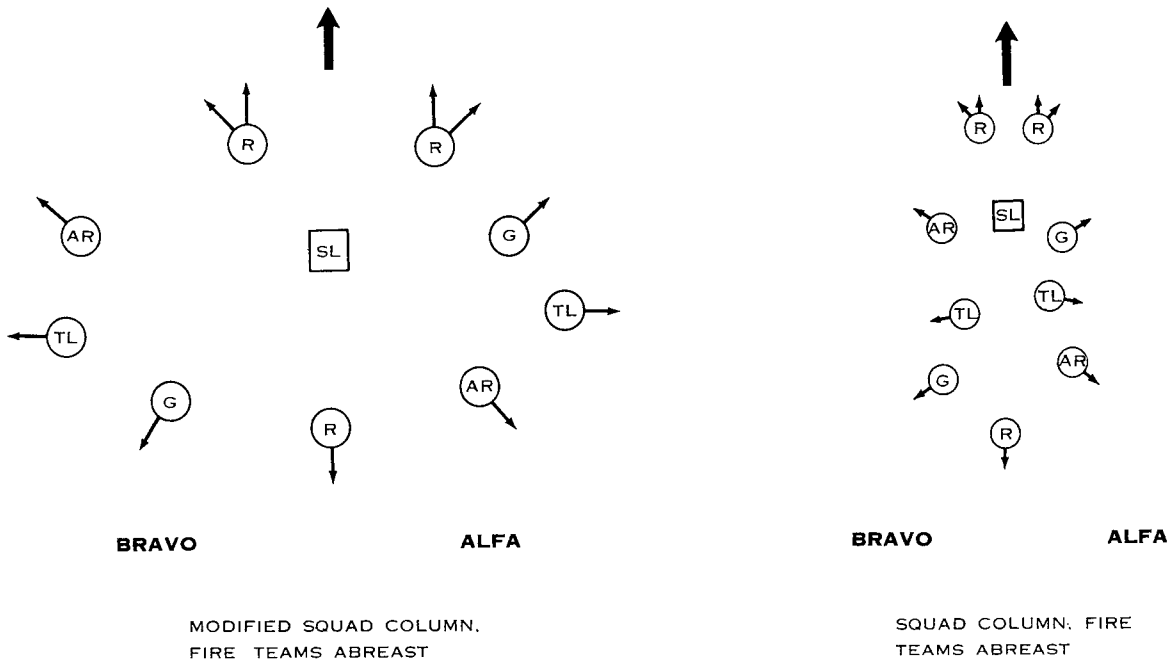


Figure 39. Squad column, fire teams abreast.

1. DIFFICULT TO CONTROL.
2. MAXIMUM FIREPOWER TO THE FRONT.
3. USED FOR THE ASSAULT AND CROSSING SHORT OPEN AREAS.

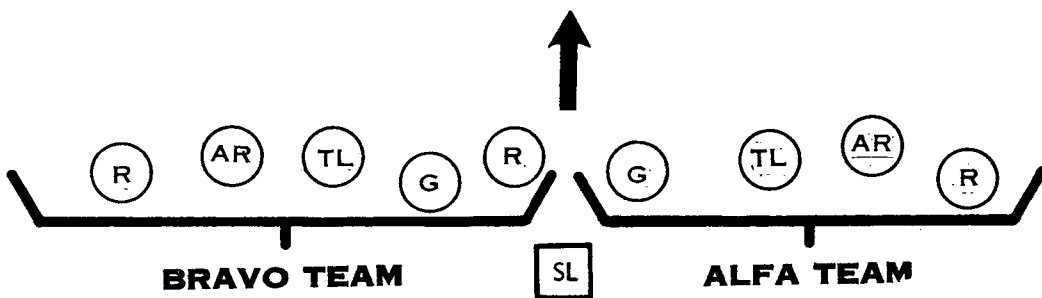


Figure 40. Squad line.

- (1) Fire team integrity is maintained.
- (2) The fire team leader is located to facilitate control of the fire team.
- (3) The automatic rifles and grenade launchers are positioned within each fire team to provide fire to the front, rear, and flanks of the squad.

*h.* Changing from one combat formation to another is accomplished without halting the squad.

## 77. Squad File

The squad file (fig. 37) is used for moving over terrain which is so restrictive that the squad cannot adopt a column formation or when visibility is so limited that control becomes extremely difficult. Deployment of the squad to the front and rear from this formation is not as easy as from the column.

## 78. Squad Column

The squad column (figs. 38 and 39) is the primary formation for movement. Squads normally use this formation as part of the platoon. It provides good dispersion without sacrificing control. In this formation, the squad can deliver a large volume of fire to the flanks, but only a limited amount to the front. The squad column is a flexible formation which facilitates fire and movement. Its two variations are fire teams in column and fire teams abreast. Both of these may be modified for greater dispersion, all-round security, and increased firepower to the front.

*a. Squad Column with Fire Team in Column* (fig. 38). This variation is used most frequently in areas where maneuver is unrestricted. The teams may be closed or the rear team may follow at a specified distance. The squad column may be modified by the squad leader as necessary to conform to the terrain and to provide a greater capability to deliver fire immediately to either the front or rear. Such modification consists of the squad leader instructing those men in the center of the formation to move to the flanks. This variation is used most frequently when the squad is separated from other elements of the platoon.

*b. Squad Column with Fire Teams Abreast* (fig. 39). This variation of the squad column is for movement in areas where maneuver of the fire teams is restricted. It is used most frequently when the squad is moving along a road or trail. Here, the enemy may have the road covered by fire which will prevent soldiers moving across the road once the squad is under fire. Consequently, fire teams are placed abreast to facilitate their deployment on each side of the road without having anyone cross it. This formation may also be modified.

## 79. Squad Line

The squad line (fig. 40) is the basic assault formation of the squad since it provides for the delivery of maximum fire to the front. Specific locations of men within the formation may be changed by the squad leader as desired. In the daylight assault, the squad leader designates a base fire team, usually the team which has been leading.

# Section IV. ARM-AND-HAND SIGNALS

## 80. General

*a.* The signals shown in this section are the common means for transmitting visual messages. The application of these signals will give the soldier a means of communication that permits greater control and coordination between him and other persons or units. They must be given correctly and distinctly so they cannot be misunderstood. They must be practiced until their use becomes second nature.

*b.* When an action or movement is to be ex-

ecuted by one or more individuals of a unit, a preliminary signal is given by pointing toward the individual(s) to execute the movement. Unless otherwise indicated, the person giving the signal will face the individual(s) for whom the signal is intended. When an action or movement is to be executed in unison, the signal for the action or movement should be preceded by the signal ATTENTION.

*c.* One signal is preferable to a combination of signals. When a combination of signals is used, give them in the order in which they are

to be executed. For example, to signal assemble in column formation, give the signal for assemble first and then column.

### 81. Standard Arm-and-Hand Signals

a. Figures 41 through 66 describe and illustrate the standard day and night prearranged

arm-and-hand signals normally used to control the movement of the squad.

b. Signals illustrated with a single-headed arrow (fig. 53) indicate that they may be repeated until acknowledged or executed. Signals illustrated with a double-headed arrow (fig. 41) will be continuous until acknowledged or executed.

## Section V. RIFLE SQUAD IN DEFENSE

### 82. General

This section provides guidance for conducting training in the fundamentals of squad defensive tactics and the integration of defensive tactics and technique of fire training. The integration of defensive tactics with technique of fire training will conserve training time and provide more realistic training. It also gives the squad members a logical framework within which to apply and control fire in a defensive situation as well as practice in the proper *tactical employment* of their weapons.

### 83. Preparation for the Defense

a. Normally, rifle squads are employed abreast with maximum firepower toward the expected direction of enemy attack. They are located to take maximum advantage of the terrain and the capabilities of their weapons. The platoon leader assigns each squad an area to organize and a sector of fire. Each squad sector of fire overlaps adjacent squad sectors (fig. 67).

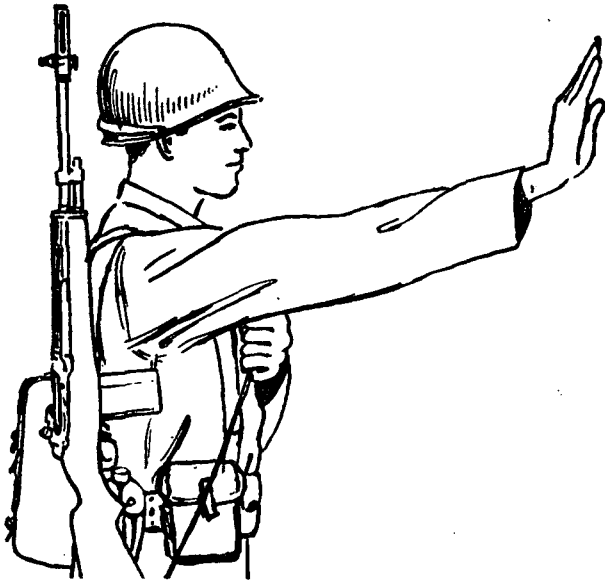
b. Within each squad the fire teams are employed on line with fire team integrity maintained. Each team occupies about half the squad area. Normally two-man foxholes are used. The choice of one-man or two-man foxholes is influenced by such factors as squad strength, fields of fire, and morale. Some of the advantages of two-man foxholes are continuous observation (while one man is resting or working, the other is alert), mutual assistance and reassurance (including first aid and assumption of both sectors of fire), and ease of redistributing ammunition.

c. The squad prepares supplementary positions as directed. These positions are organized the same as the primary positions, but are oriented to cover approaches that cannot be

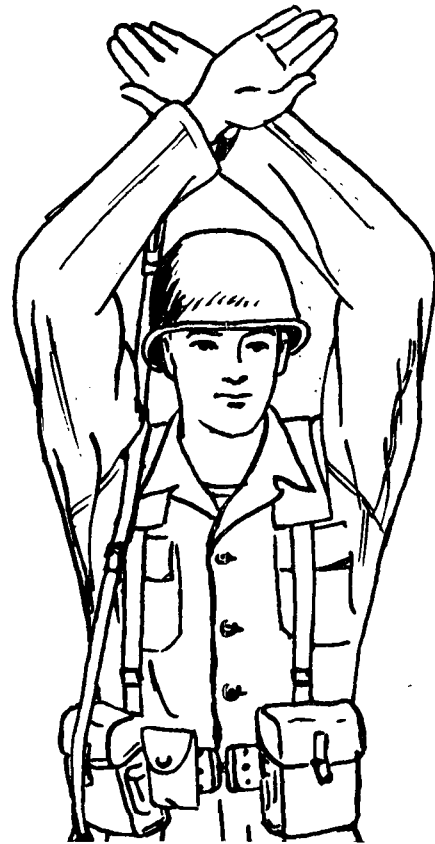
covered from the primary position. As time permits, communication trenches are prepared to provide covered routes to supplementary positions. Although the squad does not normally prepare alternate positions, such positions may be obtained by the improvement of communications trenches.



Figure 41. ATTENTION. Extend the arm sideways, slightly above horizontal, palm outward; wave arm to and from the head several times.



*Figure 42. I AM READY or ARE YOU READY? Extend the arm toward the person being signaled; then raise arm slightly above horizontal, palm outward.*



*Figure 44. DISREGARD PREVIOUS COMMAND or AS YOU WERE. Face the individual(s) being signaled; then raise both arms and cross them over the head, palms outward.*



*Figure 43. I DO NOT UNDERSTAND. Face toward source of signal. Raise both arms sideward to the horizontal; bend both arms at elbows and place both hands across the face, palms outward.*



Figure 45. *ASSEMBLE or RALLY. Raise the arm vertically overhead, palm outward and wave in large horizontal circles.*

d. Upon receiving the platoon defense order, the squad leader develops a squad order. The order is issued on the terrain to be defended, and is clear and definite so the men in the squad understand the mission and the plan. If time is limited, the squad leader may issue the order as the men are being located or after they have started the preparation of the position. The squad leader's defense order follows the operation order format which includes—

- (1) Information of the enemy, the location and identification of adjacent squads and platoons, and the location of supporting weapons within the squad area.
- (2) Mission of the squad.
- (3) Positions and sectors of fire for each team leader, rifleman, grenadier, and

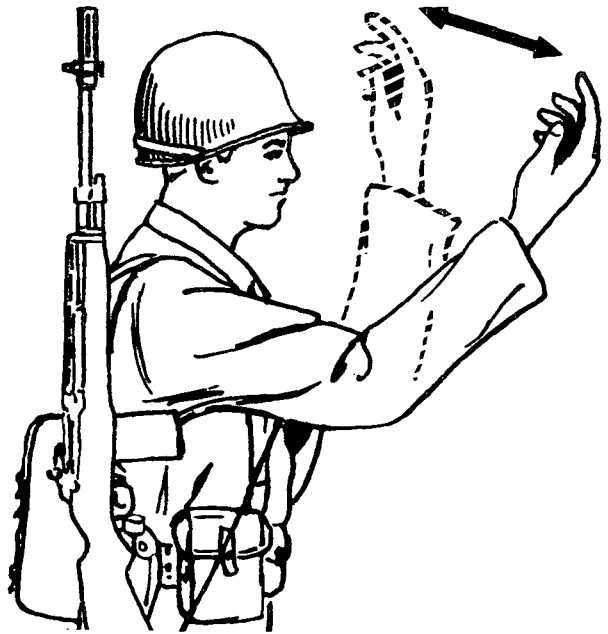


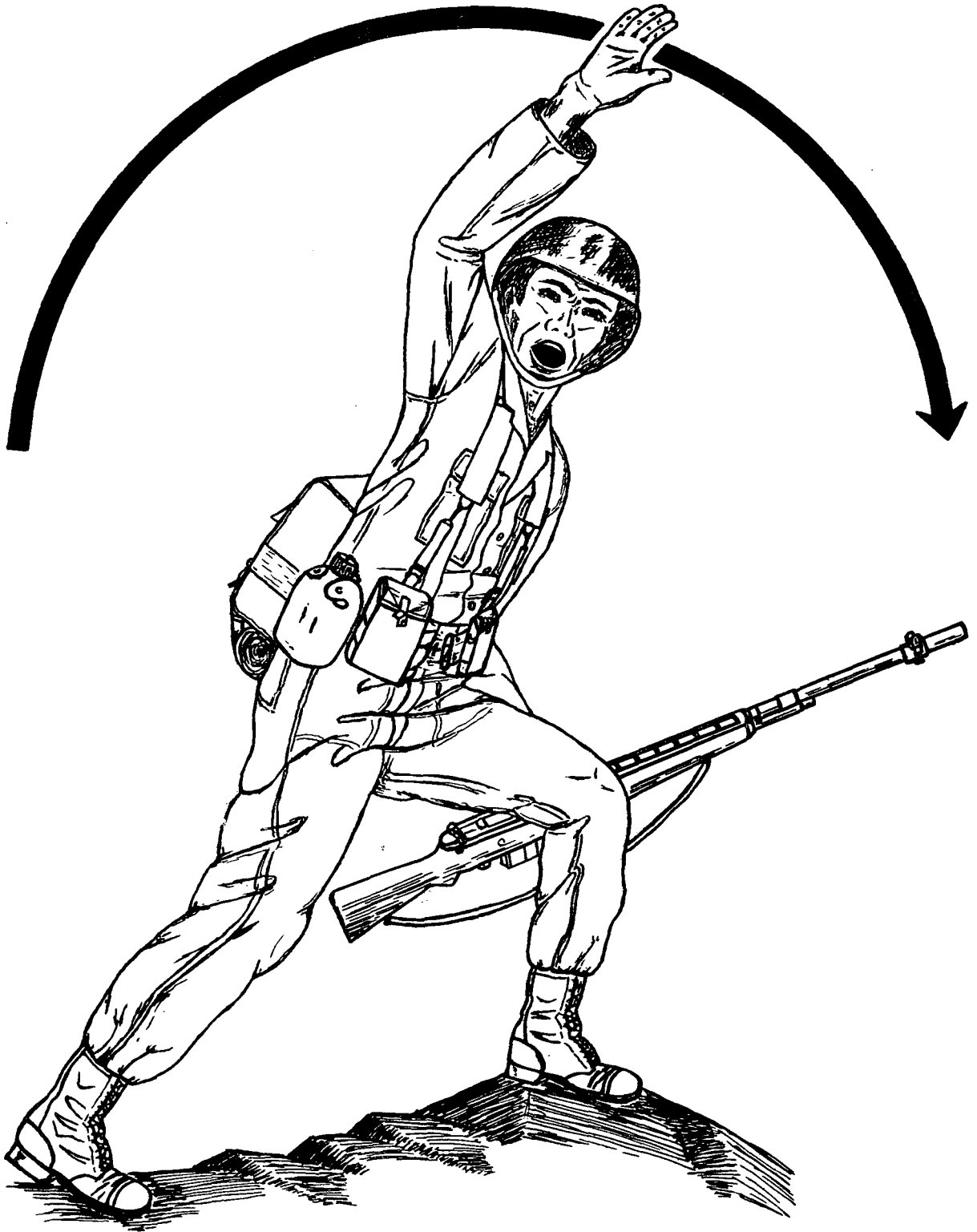
Figure 46. *JOIN ME. Point toward individual(s); beckon by holding the horizontally to the palm up, and motioning toward the body.*

automatic rifleman. Providing for antitank defense by assigning squad antitank weapons to selected members of the squad. Organization of the ground, including the type of emplacements, priority of work, and other instructions.

- (4) Administrative and supply details such as ammunition resupply and the location of the aid station.
- (5) Prearranged signals such as pyrotechnics or audible signals designating when to open fire or deliver final protective fires, and the location of the squad leader and platoon leader.

e. After issuing the squad defense order, the squad leader, in conjunction with his fire team leaders, selects firing positions for each squad member and assigns him a sector of fire. These sectors of fire overlap to insure complete coverage of the squad sector. They are marked with stakes (fig. 68) to keep the squad members oriented and aid them in finding the limits of their sectors during periods of limited visibility. Before work is started, the squad leader verifies each squad member's sector of fire.





*Figure 47. FOLLOW ME (ADVANCE). Face the desired direction of movement; hold the arm extended to the rear; then swing it overhead and forward in the direction of desired movement until it is horizontal, palm down.*

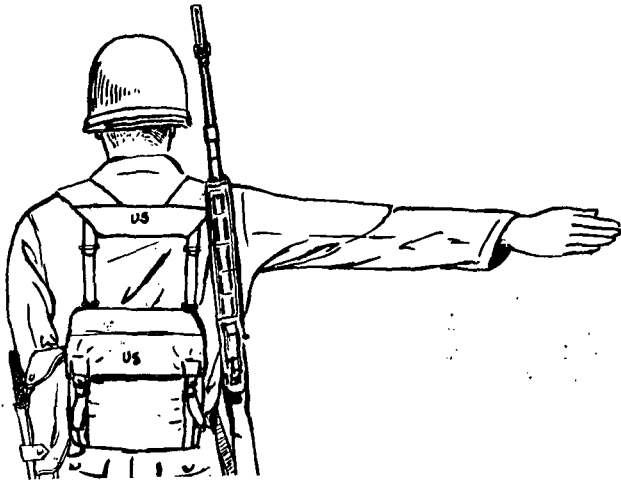


Figure 48. **RIGHT (LEFT) TURN** or **COLUMN RIGHT (LEFT)** while marching. Extend arm horizontally to the side, palm outward.

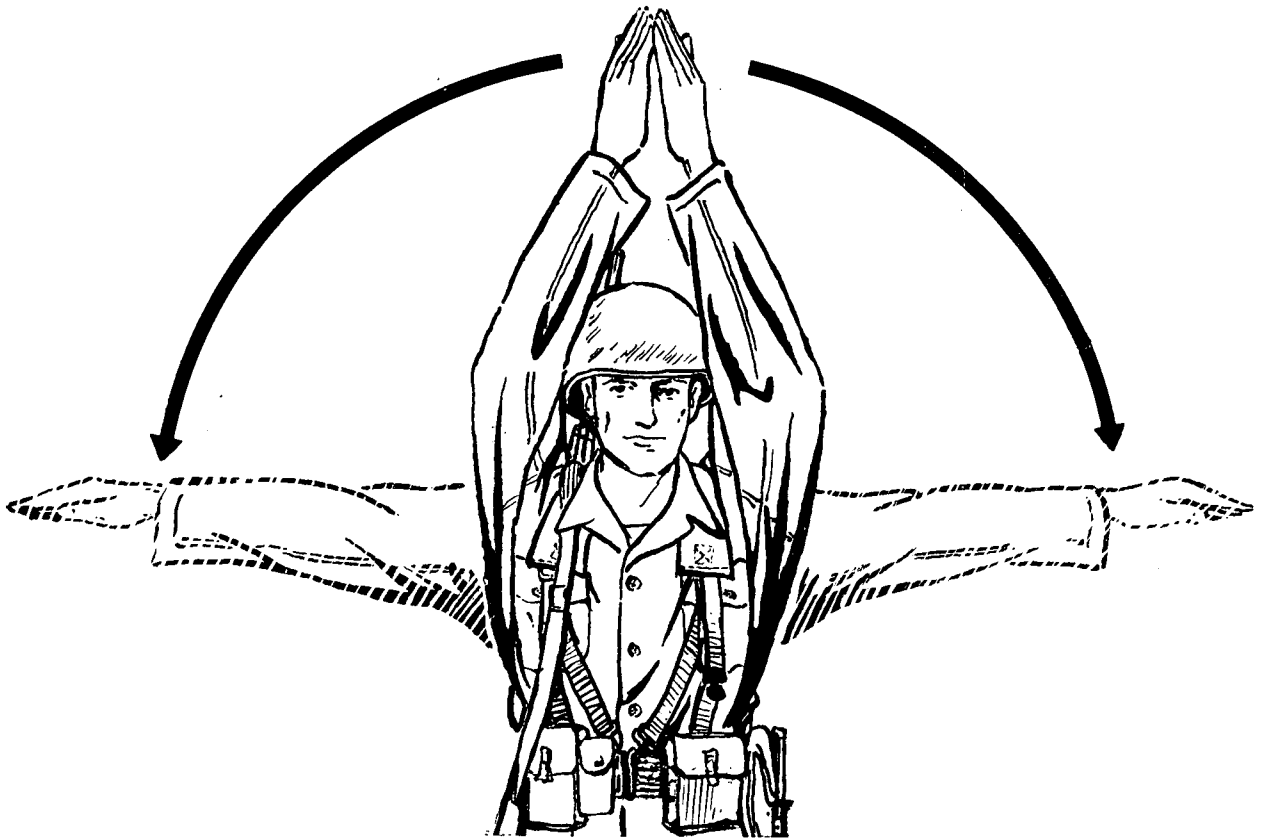


Figure 50. **INCREASED SPEED: DOUBLE TIME: or RUSH.** Raise the hand to the shoulder, fist closed; thrust the fist upward to the full extent of the arm and back to the shoulder rapidly.

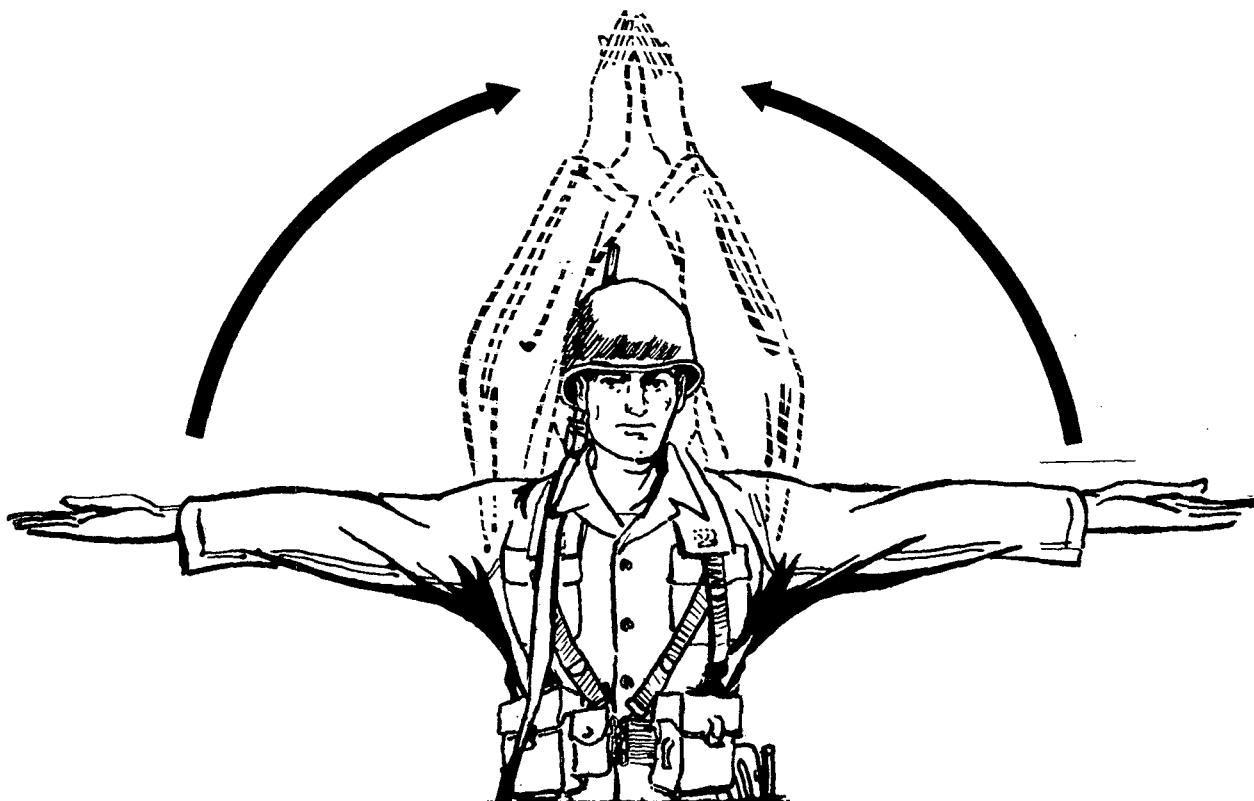


Figure 49. **HALT or STOP.** Raise the hand upward to the full extent of the arm, palm outward. Hold that position until the signal is understood.

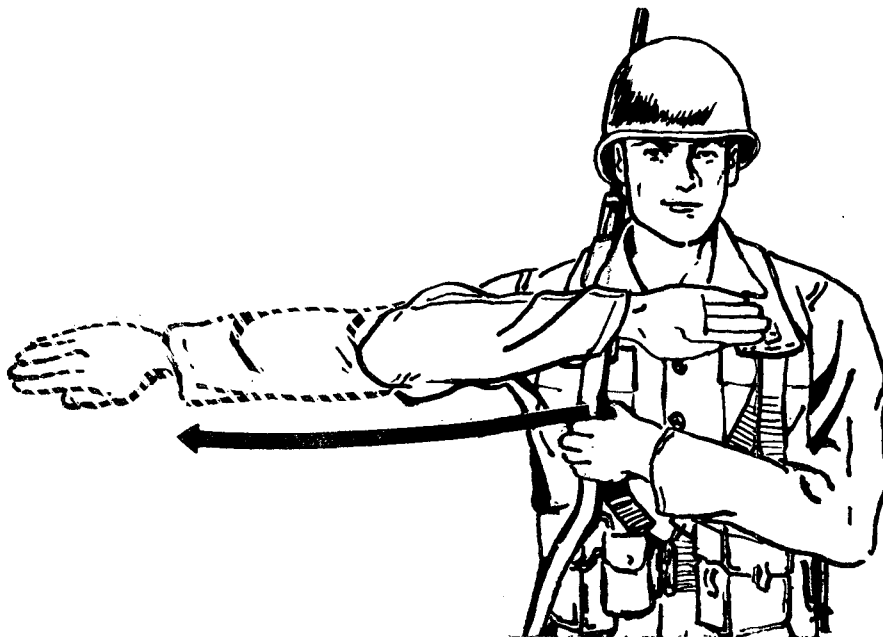
- (1) **Riflemen.** The riflemen are responsible for covering the portion of the squad sector corresponding to their position in the squad. This divides the squad sector into three individual sectors of approximately one-third for each of the riflemen.
- (2) **Automatic riflemen.** The squad leader selects firing positions and sectors of fire for the automatic riflemen. If possible, the sector assigned covers the entire squad sector. If not, the automatic weapons are assigned overlapping sectors to cover the squad sector.
- (3) **Grenadiers.** If not previously selected by the platoon leader, firing positions and sectors of fire for each grenadier are selected by the squad leader. These sectors should correspond to the squad sector or be large enough to overlap.



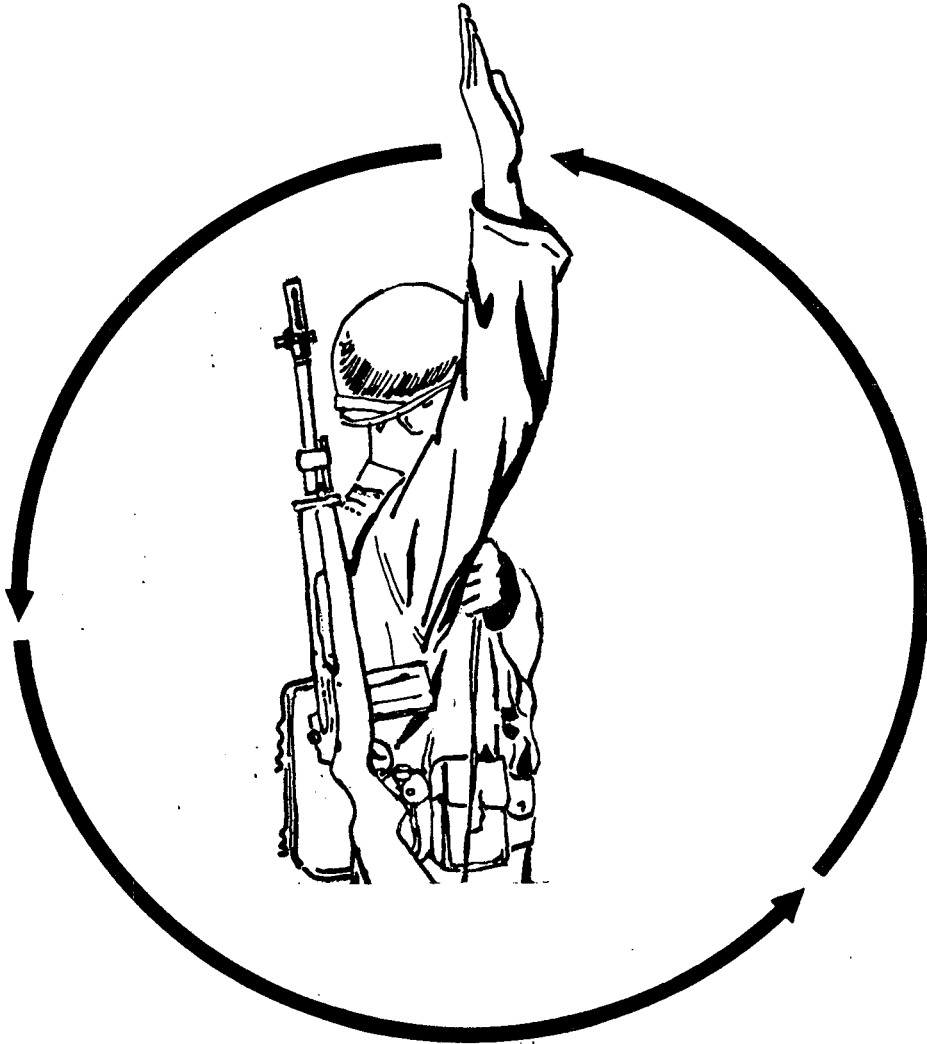
*Figure 51. EXTEND (OPEN UP). Start the signal with arms extended overhead, palms together, and bring the arms sideways to the horizontal position, palms down. When repetition of the signal is necessary, return the arms along the front of the body to the starting position and repeat the signal until understood.*



*Figure 52. CLOSE UP. Start signal with both arms extended sideward horizontally, palms up, and bring palms together overhead momentarily. When repetition of this signal is necessary, return the arms to the starting position by moving them along the front of the body.*



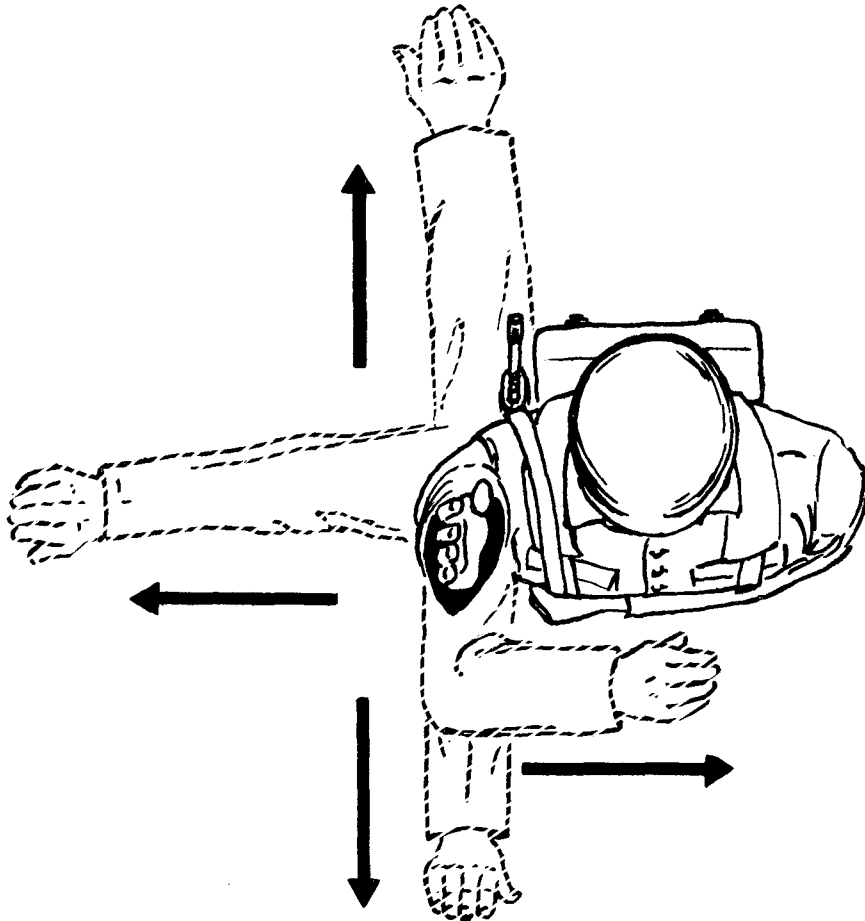
*Figure 53. MOVE OVER or SHIFT FIRE. Raise the hand that is on the side toward the new direction across the body to the opposite shoulder, palm outward; then swing the arm in a horizontal arc, extending arm and hand to the new direction. For slight changes in direction, wave hand from final positions (described above) to the desired direction of movement.*



*Figure 54. COLUMN. (One fire team behind the other.) Raise either arm to the vertical position. Drop the arm to the rear, making a complete circle keeping the arm close to the body.*



*Figure 55. COLUMN. (Fire team abreast.) Raise both arms to a vertical position; making complete circles by swinging the arms to the rear keeping them close to the body.*



*Figure 56. DISPERSE. Extend either arm vertically overhead; wave the hand and arm to the front, left, right, and rear, with the palm toward the direction of each movement.*





Figure 57. **LINE FORMATION.** Raise both arms to the side until horizontal, arms and hands extended, palms down.

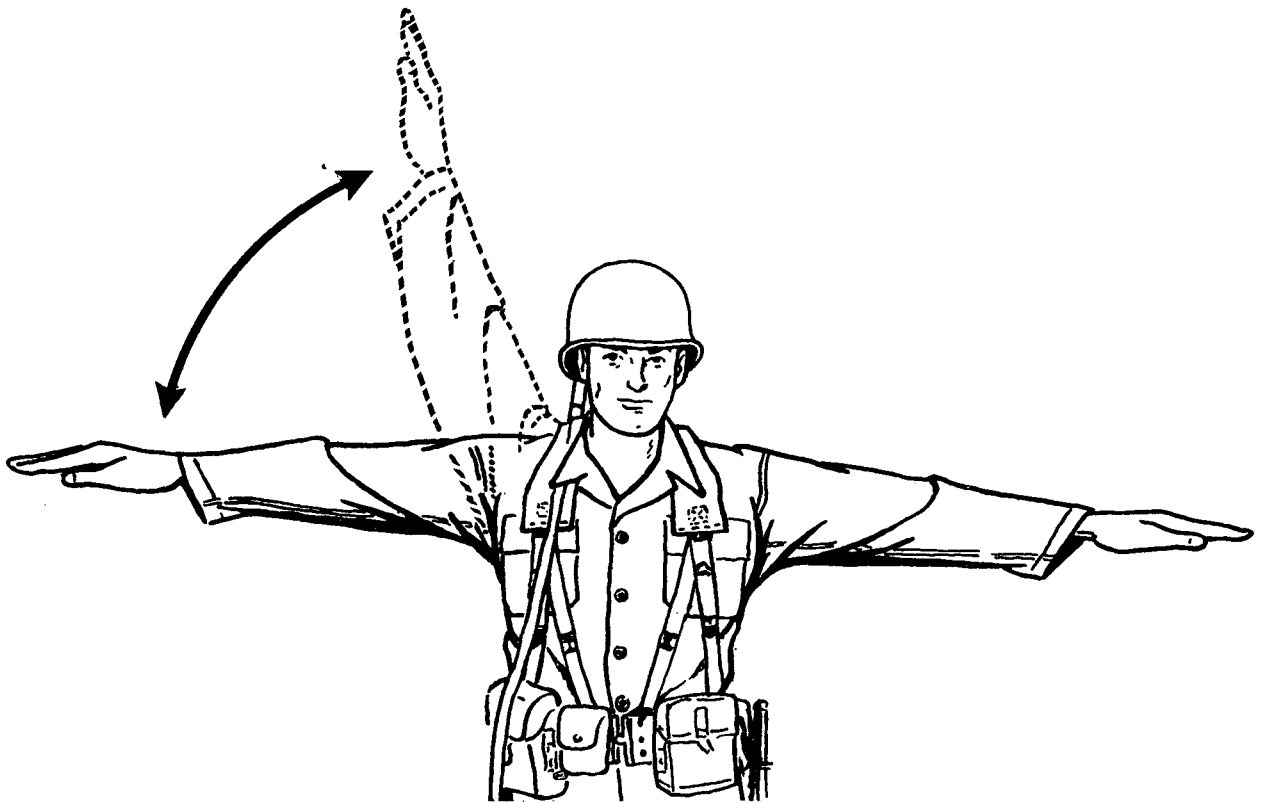
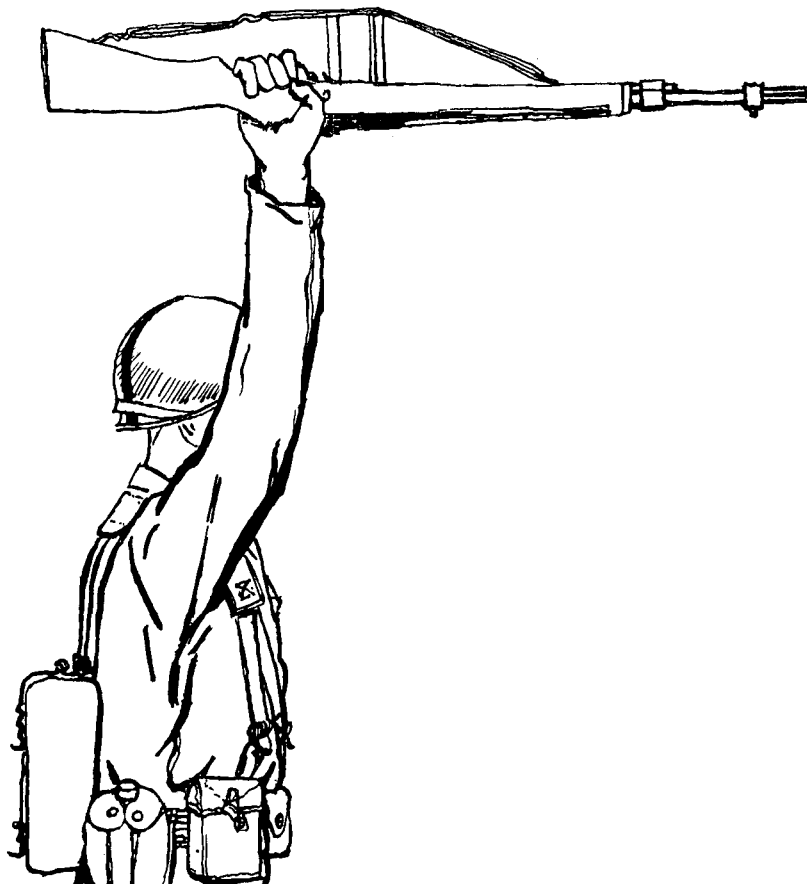


Figure 58. **LINE FORMATION, TRAILING FIRE TEAM LEFT (RIGHT).** Raise both arms to the side until horizontal; arms and hands extended, palms down. The arm on the side toward which the trailing fire team is to move is swung upward until vertical and then back until signal is completed.



*Figure 59. ENEMY IN SIGHT. Hold individual weapon above the head with one arm, fully extended, with the weapon parallel to the ground and pointing in the direction of the enemy.*



*Figure 60. FIX BAYONETS. Simulate the movement of the right hand in removing the bayonet from its scabbard and fixing it on the rifle.*

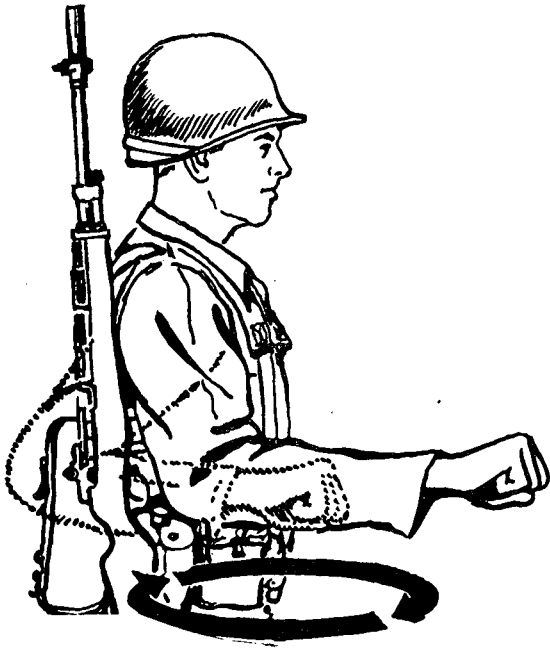


Figure 61. **PREPARE FOR ACTION.** Raise the fist to the thrust and rotate forearm several times in horizontal, clockwise circles.

(4) *Team leaders.* Team leaders are located on line and are assigned a sector of fire. Normally their sector will correspond to their team's area of responsibility.

f. The system of surveillance and fire described in *e* above, is the fundamental techniques for covering the squad sector. In favorable terrain it can be applied with very little difficulty. However, some modifications may be dictated by unfavorable terrain or unusual circumstances. For example, in jungles or extremely mountainous terrain, it may be necessary to assign the team leaders, automatic riflemen, and grenadiers individual sectors in order to cover the entire squad sector. Nevertheless, the fundamental technique (fig. 68) will work in most situations, and should be the goal of every squad when the terrain and circumstances will permit its application.

g. All firing positions, to include supplementary positions, must be camouflaged. Unnecessary noise and movement are held to a mini-

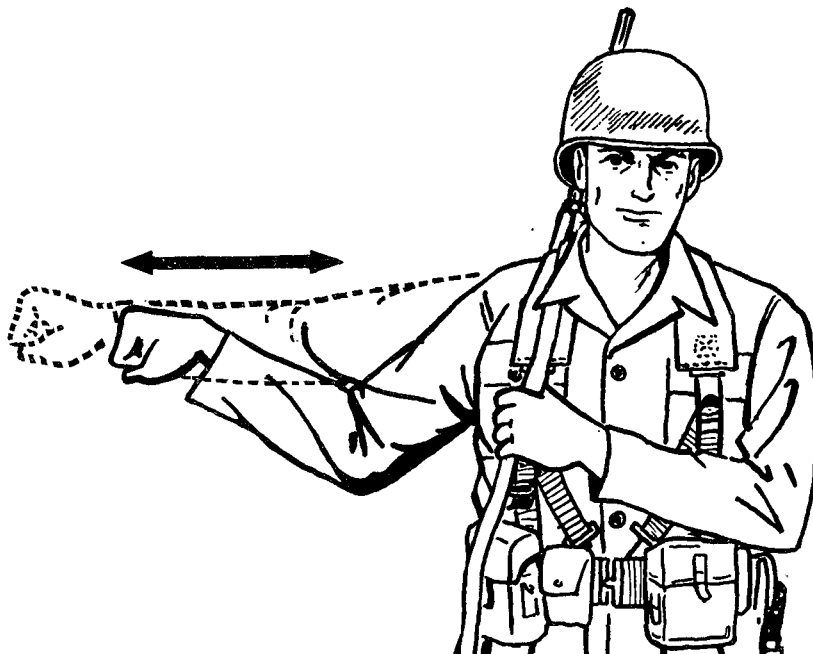


Figure 62. **ACTION FRONT (RIGHT, LEFT, or REAR): FIGHT ON FOOT; or ASSAULT FIRE.** Raise fist to shoulder level and thrust it in the desired direction of action.



Figure 63. COVER OUR ADVANCE. Strike top of head or helmet repeatedly with open hand.

mum. The squad leader accomplishes this by requiring his men to—

- (1) Stay within shadowed areas whenever possible.
- (2) Utilize branches and leaves to break up the outline of soldiers, weapons, and equipment.
- (3) Conceal mess gear, range cards, rations, ammunition containers, and all other light colored or glittering objects.
- (4) Break up solid areas of color and blend them with the natural surroundings.
- (5) Hide or dispose of freshly dug earth. Change the regular outline of emplacements by camouflaging them with natural material.
- (6) Use only selected paths for movement within and around the position.

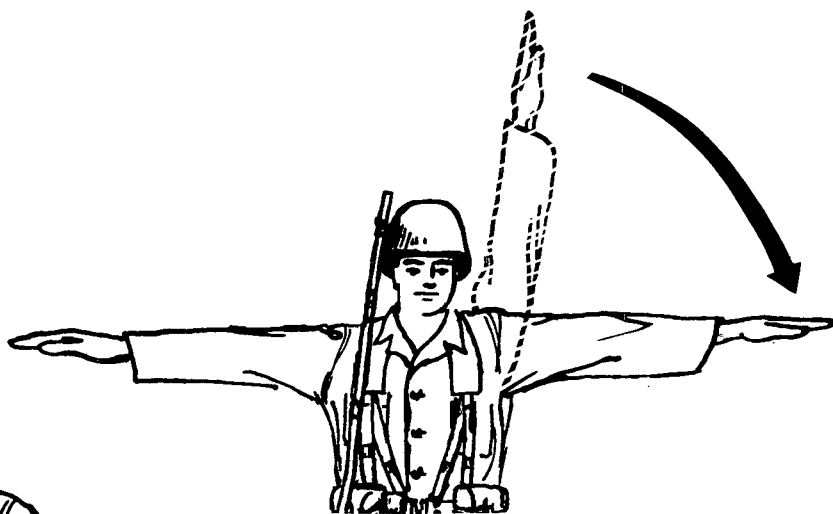
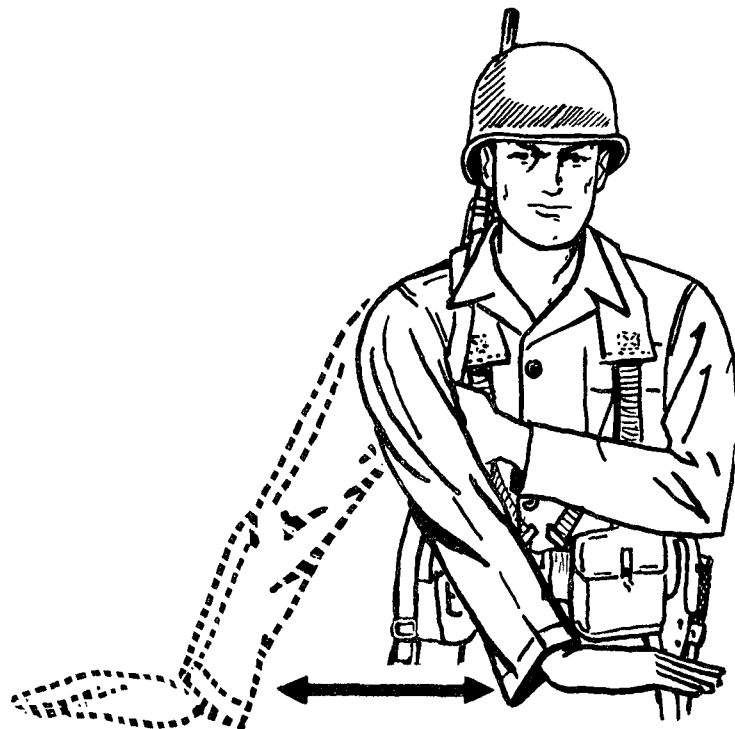


Figure 64. MANEUVER FRONT RIGHT (LEFT) FROM SQUAD COLUMN, drop arm from the vertical position to the horizontal position in the direction of maneuver.

h. The squad leader's responsibilities during the preparation of the position include:

- (1) Effecting necessary coordination with adjacent squads.
- (2) Effecting necessary coordination when other weapons are located in the squad area.
- (3) Supervising the preparation of fox-holes and other field fortifications.
- (4) Supervising the preparation of range cards to include assisting in the determination of ranges to prominent landmarks.
- (5) Supervising the clearing of fields of fire.
- (6) Supervising the preparation of supplementary positions.
- (7) Inspecting the positions to insure that camouflage and overhead cover are sufficient.
- (8) Insuring all weapons are properly zeroed.
- (9) Preparing a sketch of the squad's sector of fire, showing prominent landmarks or terrain features and the ranges to them.

i. The rifle squad provides for its security by alertness and by implementing its part of the platoon security plan. Enough squad members are kept alert to maintain an effective warning system. When a defensive position is being

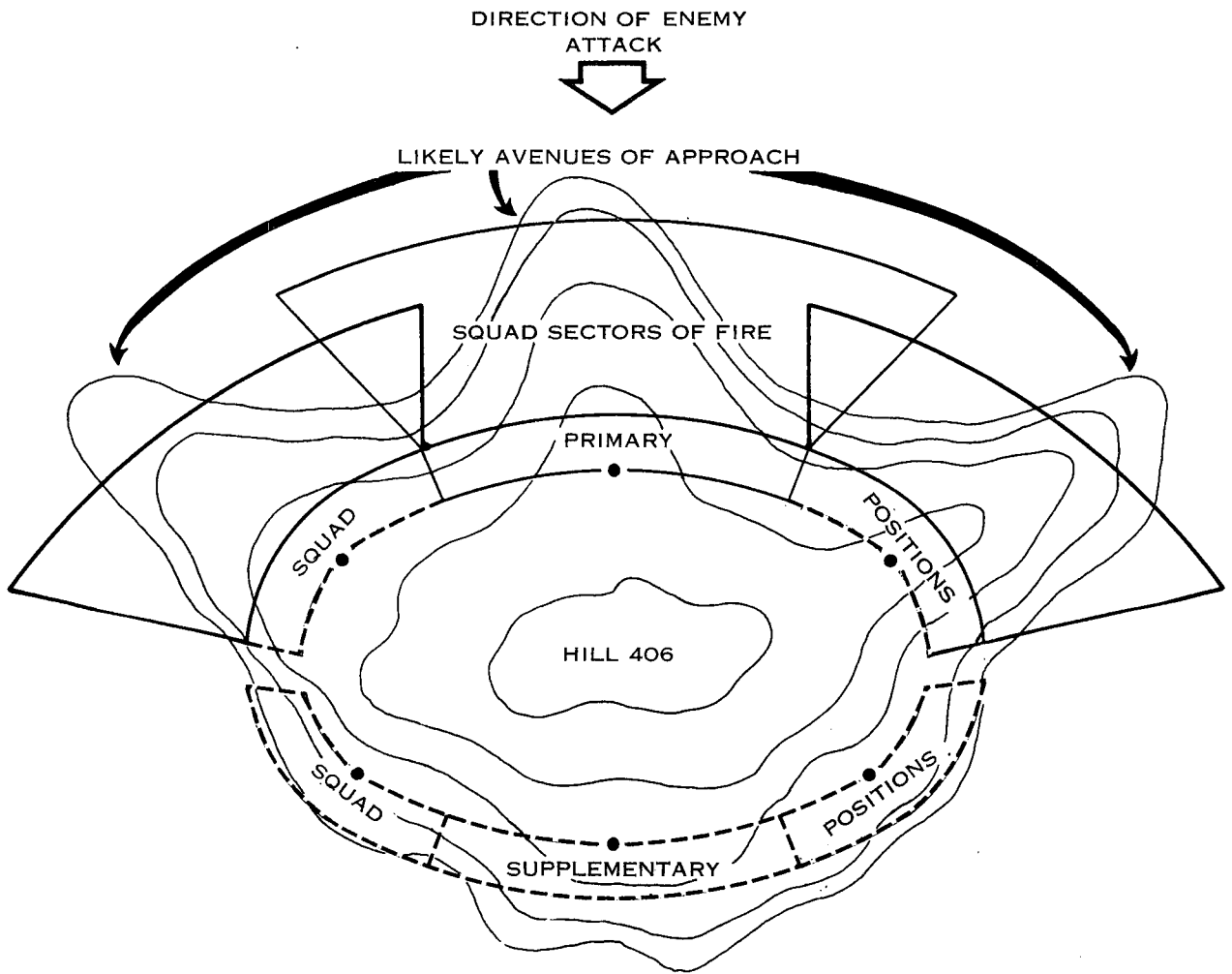


*Figure 65. COMMENCE FIRING. Extend arm in front of the body, waist high, palm down, and move it through a wide horizontal arc several times. FIRE FASTER—Execute the signal for COMMENCE FIRING rapidly. FIRE SLOWER—Execute the signal for COMMENCE FIRING slowly.*



*Figure 66. CEASE FIRING. Raise the hand in front of the forehead, palm outward, and swing the hand and forearm up and down in front of the face.*

prepared during the hours of daylight and the enemy is not close to the squad's position, a minimum of one sentinel is posted in the squad area to give warning of enemy ground or air approach. During periods of limited visibility and when the enemy is known to be close to the squad's position, additional security measures are necessary. The number of men kept on the alert during such periods will vary. When the enemy is known to be close to the squad's position, the entire squad may be kept on the alert. When platoon, company, or higher unit security elements are located to the squad's front, two to five men kept on the alert in the squad area may be sufficient. The squad leader must keep his men prepared for future action by allowing them periods of rest when the situation permits. The frequency of relief for sentinels and listening posts is affected by such considerations as the physical condition of the men, effects of extreme weather conditions, morale, and strength of the squad. As a guide, relief every 2 hours is desirable.



*Figure 67. Squad sectors of fire.*

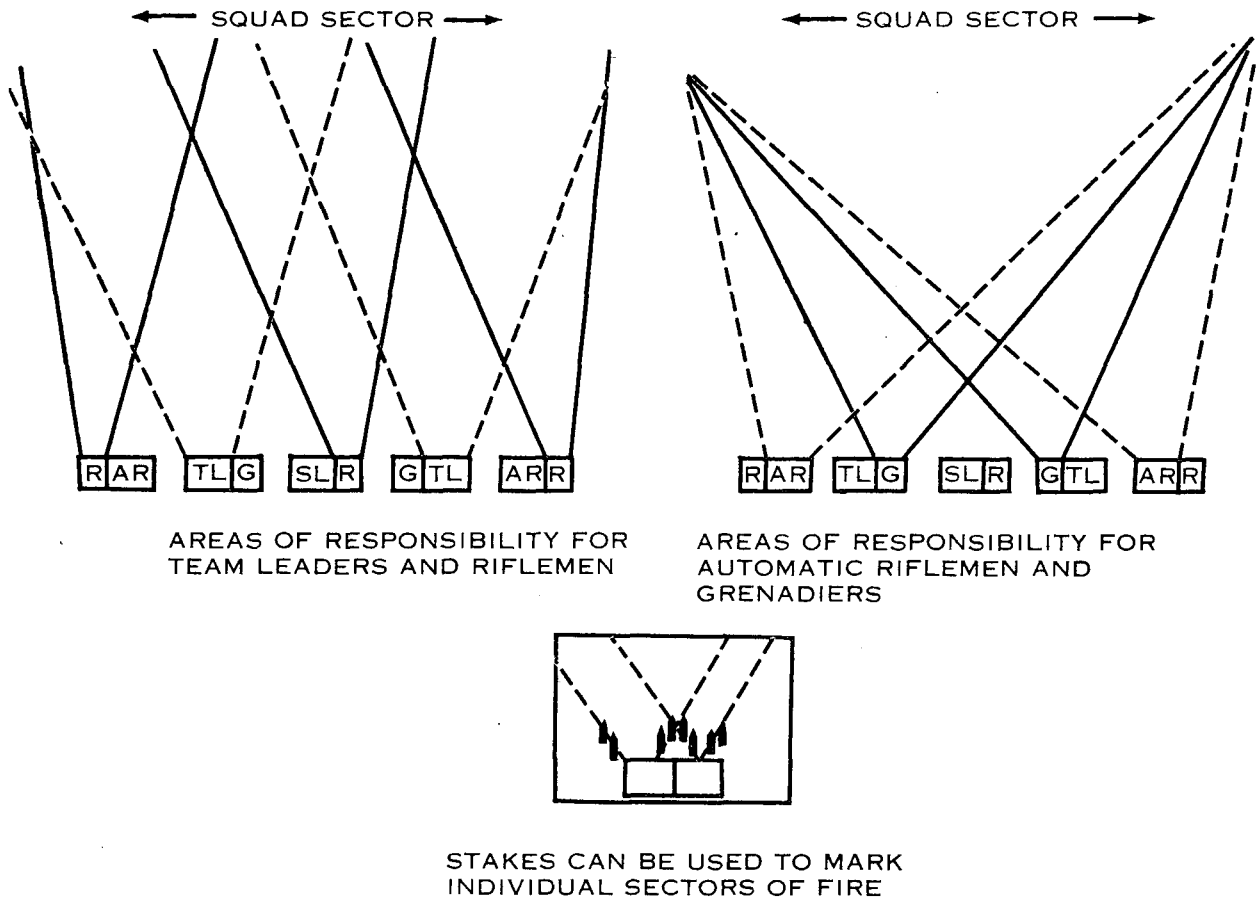


Figure 68. Use stakes to mark sectors of fire.

*j.* The squad leader anticipates the difficulties of control during the conduct of the defense. He makes maximum use of the methods of control (arm-and-hand signals, pyrotechnics, audible signals, and passing orders from man to man). He also plans expedients to aid him in overcoming the difficulties of control. An example of such an expedient is stringing wire or string along the line of foxholes and establishing a set of pull signals to transmit messages. Communication trenches should be dug between foxholes as time permits.

#### 84. Conduct of the Defense (Day)

*a.* As the enemy approaches friendly defensive positions, various targets will appear in the squad sector of fire. The squad engages these targets as soon as they come within effective range (long-range fires). To effectively engage and destroy these targets, the squad

must apply what it has learned in both *technique of fire* and *squad defensive tactics*.

*b.* The most common target appearing in the squad sector will be enemy troops in a line formation employing fire and movement. To engage and destroy such a target, the squad applies those techniques described in paragraph 17.

*c.* Normally a column type target will not appear in the squad's sector. If it does, it is engaged by the application of the techniques described in paragraph 18. Also, the squad may find itself in a position to ambush an enemy column during a patrol action, and the application of the same techniques would serve that purpose.

*d.* When confronted with a point target the squad applies the techniques described in paragraph 19.

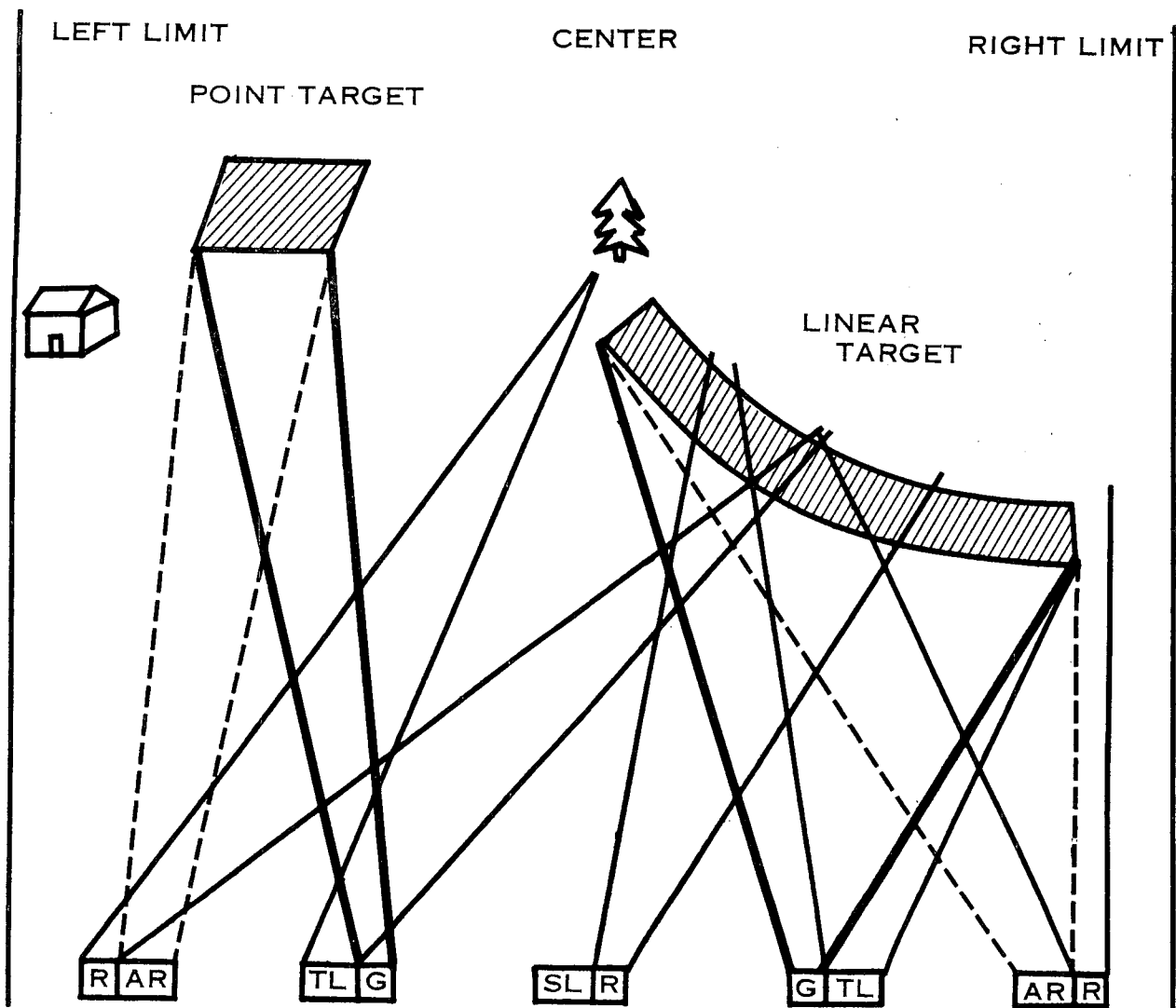


Figure 69. Shifting fire (BRAVO team automatic rifleman and grenadier shift to cover point target, ALFA team automatic rifleman and grenadier shift to cover entire linear target).

e. As the close defensive fires begin to break the enemy formation, the squad may be presented with several types of targets at the same time. As additional targets appear in the squad sector, the fires of certain individuals within the squad are shifted to these new targets. This shifting of fire must be accomplished in a minimum of time without disrupting the fire on the original target. For example, if the squad is engaging a linear target and an enemy machinegun appears, the squad leader may—

- (1) Shift the fires of one team's automatic rifleman and grenadier to engage the enemy machinegun and the

fires of the other team's automatic rifleman and grenadier to cover the entire linear target (fig. 69).

- (2) Shift the fires of both grenadiers to engage the enemy machinegun, leaving the automatic riflemen to continue firing on the linear target (fig. 70).
- (3) Shift the fires of both automatic riflemen onto the enemy machinegun, leaving the grenadiers to continue firing on the linear target (fig. 71). This method is especially applicable when point targets appear beyond the effective range of the grenadiers (350



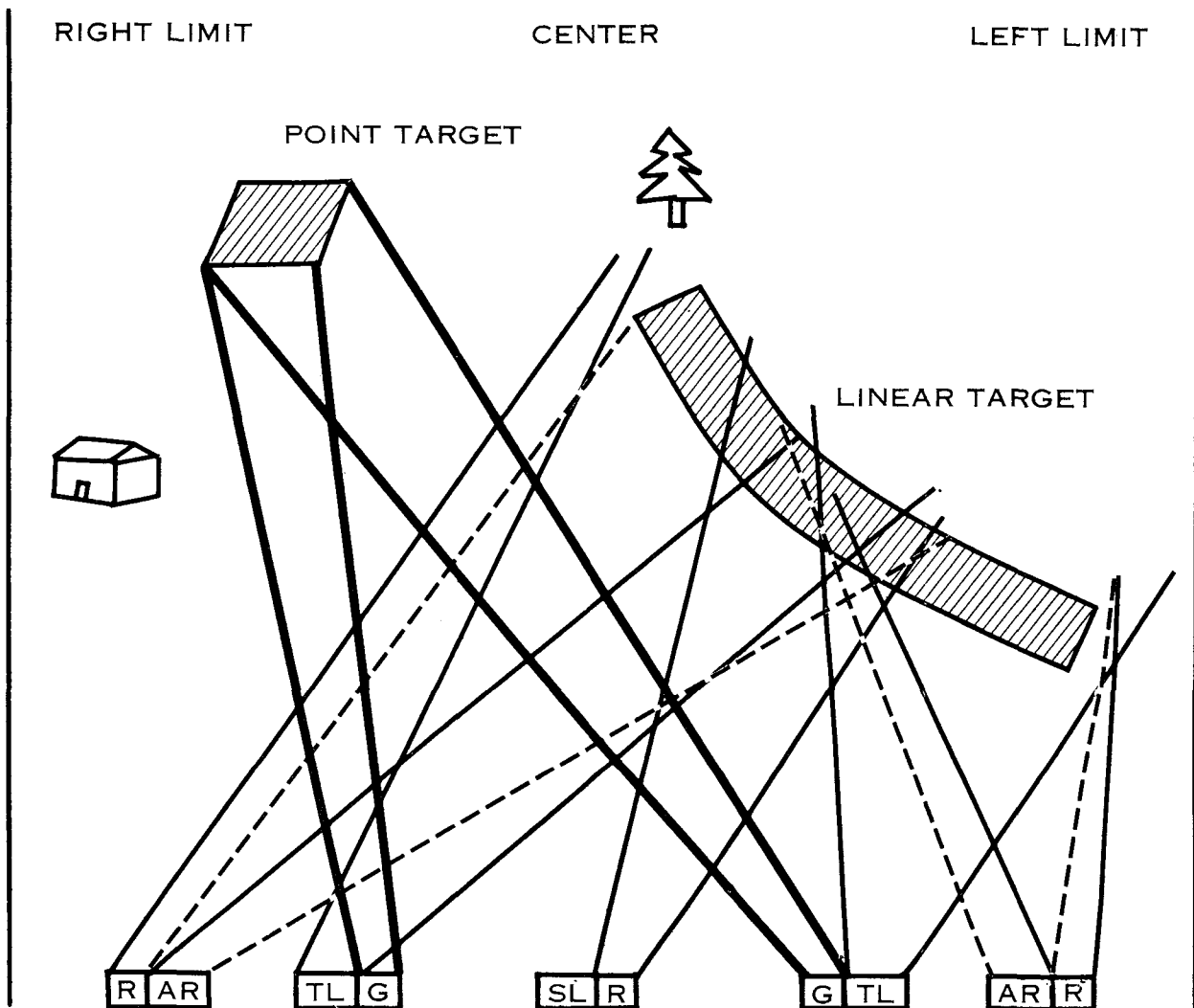


Figure 70. Shifting fire (both grenadiers shift to cover point target, automatic riflemen continue to cover linear targets).

meters), which may often be the case with the enemy crew-served weapons.

f. Shifting fire is a problem of *fire control*. The squad leader can use any of the methods of control described in paragraphs 23 through 28 to have individual squad members shift their fire. However, the most effective method is by establishing SOP's which require appropriate squad members to shift their fire automatically. For example, the SOP described in paragraph 24g requires the riflemen to shift their fire without order, from the squad target to engage appropriate targets of opportunity within

their sectors of fire. It also requires the automatic riflemen to shift their fires from the squad target to engage enemy automatic weapons appearing anywhere in the squad sector.

g. If the enemy continues to advance through the close defensive fires and starts his assault, the platoon leader calls for final protective fires. When final protective fires are called for, all squad members fire in their individual sectors at a maximum effective rate until told to stop. When the enemy is repelled, the squad again uses the appropriate techniques for engaging targets within its sector of fire.

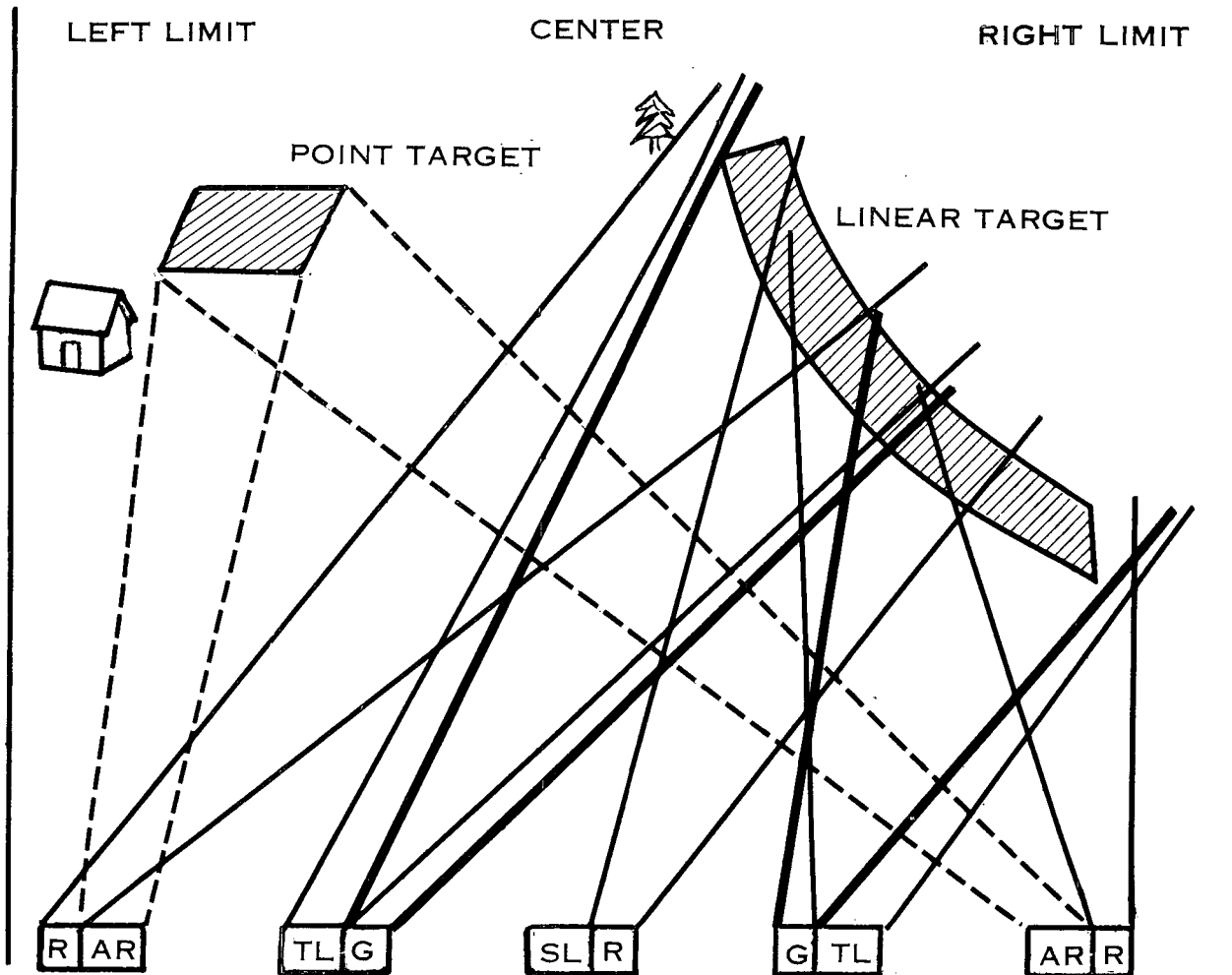


Figure 71. Shifting fire (both automatic riflemen shift to cover point target, grenadiers continue to cover linear target).

### 85. Conduct of the Defense During Periods of Limited Visibility

During periods of limited visibility, the defense is conducted in essentially the same manner as described in paragraph 84. During periods of limited visibility, *surprise* and *close combat* are more likely to occur. For this reason, security (additional patrols and listen-

ing posts) and fire discipline are emphasized. Needless expenditure of ammunition and premature disclosure of positions are avoided by firing only when targets are visible. If artificial illumination is provided, daylight techniques are used. Otherwise, the squad applies those techniques described in paragraphs 47 through 52.

## Section VI. RIFLE SQUAD IN THE ATTACK

### 86. General

This section provides guidance for training in the fundamentals of squad offensive tactics and the integration of offensive tactics with technique of fire training. At squad level, the

emphasis is placed on fire and movement and assault fire techniques. However, the squad members must be familiar with all phases of the attack and the missions a squad may be assigned as part of an attacking platoon.

## 87. Preparation for the Attack

*a.* The squad prepares for the attack in its assigned portion of the platoon assembly area. Security is maintained by posting sentries and using camouflage and concealment. Shelters dug for protection against indirect fire. Upon receipt of the platoon warning order, the squad leader issues a warning order to the squad members. This is a brief fragmentary order containing time of attack and details such as drawing special equipment, ammunition and rations; and turning in extra equipment. The squad then prepares for the attack to include turning in and drawing of equipment, ammunition and rations; checking and cleaning weapons, and setting battlesights.

*b.* Upon receipt of the platoon attack order, the squad leader makes a reconnaissance. During his reconnaissance, the squad leader studies the terrain, paying particular attention to the route, landmarks on which to guide, and known or suspected enemy positions. Based on this, he plans the actions of his squad from the time it crosses the line of departure through consolidation of the objective. He plans in detail his assigned tasks, any anticipated action at danger areas along the route (such as seizing key terrain short of the objective), and his squad's part in the assault and consolidation.

*c.* Time permitting, the squad leader issues his order in the assembly area, using an improvised terrain model or sketch to orient his men. Often the available time will be so limited the squad leader must issue his order while moving forward from the assembly area or in the attack position. The squad leader should orient his men on the terrain as soon as possible. The squad leader's order follows the operations order format which includes—

- (1) Information of the enemy, the mission of the platoon, and the location and mission of adjacent units.
- (2) Mission of the squad.
- (3) Plan of attack to include formations to be used, routes, plans for seizing key terrain features, deployment on the final coordination line, and consolidation.
- (4) Administrative and supply details

such as ammunition resupply and the location of the aid station.

- (5) Prearranged signals to be used during the attack and the location of himself and the platoon leader.

## 88. Conduct of the Attack (Day)

A rifle squad may act as part of either the fire support element or the maneuver element of the platoon. If a squad is part of the fire support element, it will use the techniques for applying fire as described in paragraphs 14 through 22. If the squad is employed as part of the platoon maneuver element, it accomplishes its mission as follows:

*a.* Upon leaving the attack position, the squad makes a rapid and continuous advance across the LD to the final coordination line.

*b.* If subjected to artillery or mortar fire along the route, the squad moves quickly through or around the impact area.

*c.* When enemy resistance is encountered short of the objective, fire is returned immediately. If the platoon leader decides not to bypass the resistance and orders a squad to eliminate it, the squad must move aggressively to do so. Normally, fire alone will not be decisive. When a squad cannot eliminate the enemy by fire, it uses fire and movement (par. 89).

*d.* As the squad approaches the final coordination line, it completes its deployment in preparation for the assault. When the effectiveness of the enemy fire has been sufficiently reduced by supporting fires, assault fire techniques are employed (par. 22) to close with and destroy the enemy. This condition cannot be predetermined prior to crossing the final coordination line, but may occur at any time between the final coordination line and the objective. When the effectiveness of enemy fire has not been sufficiently reduced by supporting fires, the squad uses fire and movement to overcome pockets of resistance and seize the objective.

*e.* The assaulting troops clear the enemy positions and move through the objective far enough to place fire on any withdrawing elements and to protect against a counterattack. The squad then moves to its area of responsi-

bility and begins putting into effect the plans for consolidation and reorganization as follows:

- (1) *Consolidation.* Plans for consolidation of the objective are made prior to the attack and adjusted as the situation dictates. Immediately after seizing the objective, the squad prepares to repel a possible counterattack. Security is posted to warn of the enemy approach. The squad leader, assisted by the fire team leaders, assign individual positions and sectors of fire. In addition, automatic riflemen and grenadiers are assigned principal directions of fire covering critical approaches. Men dig in immediately.
- (2) *Reorganization.* Reorganization is a continuing process. It is given special emphasis upon seizure of the objective. During the attack the squad may have received casualties, expended ammunition, and perhaps lost equipment. Key men who have become casualties are replaced. Ammunition is redistributed within the squad. Casualties are placed in a covered position while awaiting evacuation. Lost or damaged equipment is replaced or requested.

## 89. Fire and Movement (Battle Drill)

Units in combat are often faced with unexpected situations. Battle drill has been developed to allow the unit to react quickly and correctly in these situations without issuing lengthy orders. In using battle drill, the squad leader decides on the action to be taken and directs the squad accordingly. Battle drill results in immediate fire and movement.

### *a. Organization for Fire and Movement.*

- (1) The two fire teams of the rifle squad provide the squad leader with two elements to execute fire and movement. One fire team is the movement element while the other is the fire support element. However, the role of each element may change during the attack. For example, if the movement element is prevented by enemy action or terrain from closing with the

enemy, it assumes the fire support role to cover the advance of the other element, which then becomes the movement element.

- (2) The organization of the squad into two fire teams does not prevent the squad leader from organizing his movement and fire support elements to conform to a specific situation. For example, when more firepower is required in the fire support element than can be provided by one fire team, the squad leader may designate the automatic riflemen, grenadiers, and one of the fire team leaders to act as the fire support element. The remainder of the squad then becomes the movement element. However, such a subdivision takes time to accomplish and the squad loses some of its flexibility.

*b. Fire Support Element.* The fire support element covers the movement element in its advance toward the enemy position by engaging all known or suspected targets. This element is aggressive in its action, and continues to move closer to the objective if such action is possible without reducing the volume of fire. Such movement is normally accomplished through individual rushes. When the fires of the supporting element are masked, it moves forward to join in the assault or assist in consolidation. Once designated, the fire support element must shift fire to cover the entire target area and increase its rate of fire to compensate for the loss of fire of the movement element. This is accomplished by the application of techniques which insure complete coverage of the objective by rifle, automatic rifle, or grenade launcher fire. The following examples show how fire is shifted in situations where these combinations of weapons are used in the fire support element:

- (1) *ALFA team.* The grenadier and automatic rifleman distribute fire over the entire target area, using appropriate techniques. The team leader and rifleman distribute fire over their respective halves of the target area, supplementing the fires of the grenadier and automatic rifleman (fig. 72).

(2) *BRAVO team.* The grenadier and automatic rifleman distribute fire over the entire target area using appropriate techniques. The riflemen distribute fire over their respective half of the target area, and the team leader fires as required and directs the fires of other team members (fig. 73).

(3) *Modified fire support element.* With a fire support element composed of two grenadiers, one automatic rifleman, and a team leader, the grenadiers distribute fire on their respective half of the target area and the automatic rifleman on the entire area. The team leader fires where his fire will be most effective (fig. 74).

*c. Movement Element.* The mission of the movement element is to close with and destroy or capture the enemy. It advances and assaults under the close fire support of the fire support elements. Its principal job is to maintain the advance toward the enemy. It uses available cover and concealment to the maximum. Depending upon the terrain and effectiveness of the supporting fire, the movement element advances by fire team movement, fire and movement within the team (figs. 75 and 76), and creeping and crawling. Regardless of the method, it must continue to advance.

## 90. Assault Fire (Day)

When assault fire techniques are used the squad deploys in line formation and closes with the enemy, moving rapidly. Squad weapons are fired in accordance with the techniques described in paragraph 22. This phase of the attack is characterized by volume and accuracy of fire and violence of action. The squad members shout and create as much noise as possible. All available weapons to include grenades and bayonets are used to overcome pockets of resistance. Elements of the assaulting echelon gaining a foothold within the enemy positions support the remainder of the assault by fire.

## 91. Squad in the Night Attack

(fig. 35)

*a.* Night attacks are a part of normal operations and become more frequent when enemy

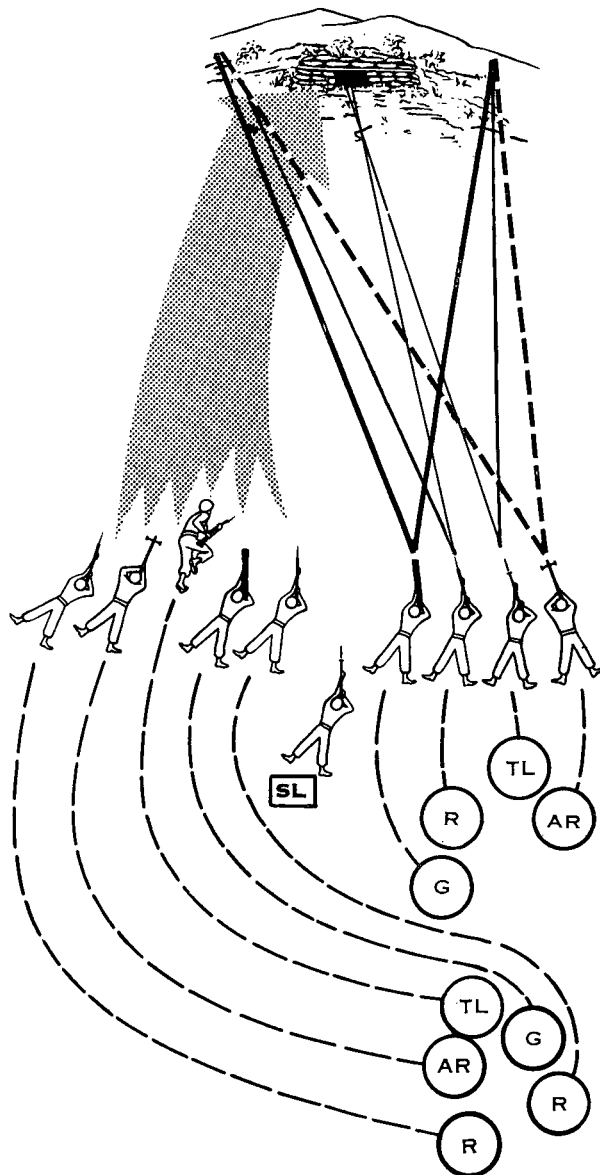


Figure 72. Distribution of fire while employing fire and movement (maneuver front—left).

firepower makes daylight operations more hazardous. During periods of limited visibility (fog, snow, or smoke), some or all of the techniques discussed in this paragraph may apply to an attack during daylight hours. This paragraph deals primarily with the techniques used in an attack by stealth, in which the attacker attempts to maintain secrecy and achieve surprise in closing with the enemy before the attack is discovered.

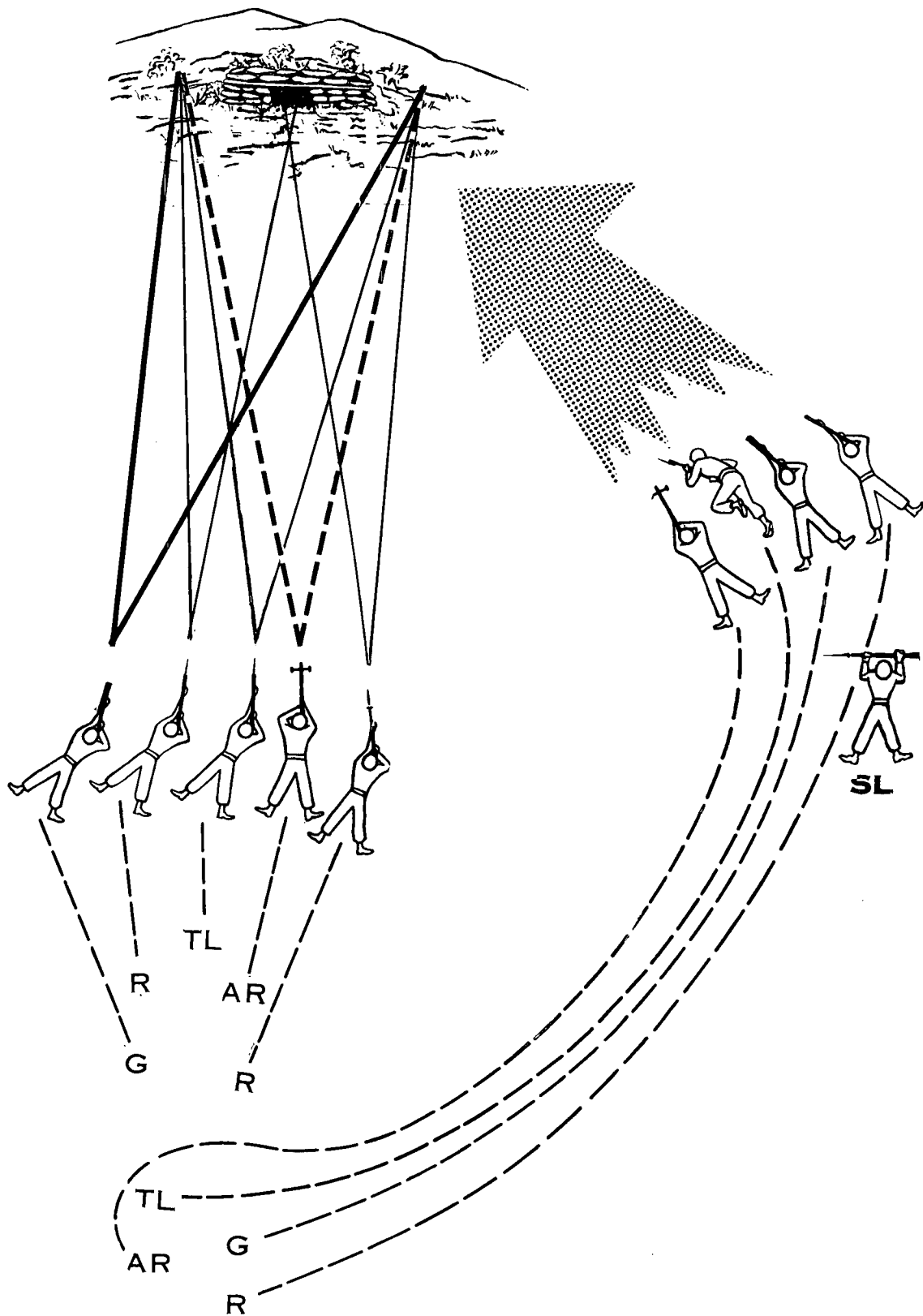


Figure 73. Distribution of fire while employing fire and movement (maneuver front—right).

b. Night combat is generally characterized by—

- (1) A decrease in the ability to place aimed fire on the enemy.
- (2) An increase in the importance of close combat, volume of fire, and the fires of certain weapons laid on targets, during daylight.
- (3) Difficulty of movement.
- (4) Difficulty in maintaining control, direction, and contact.

Despite these difficulties, the night attack gives the attacker a psychological advantage in magnifying the defender's doubts, apprehension, and fear of the unknown.

c. The conduct of the attack, *d* and *e* below, requires that the attacking elements reach the PLD without being discovered. If the attack is discovered prior to this, the unit commander will normally call for illumination and planned

supporting fires. The attack then continues as in a daylight operation. If illumination is provided throughout the attack, the tactics and techniques are generally the same as for a daylight attack, except that problems of coordination and control are greater.

d. The conduct of the night assault and delivery of assault fires is covered in detail in paragraphs 53 through 55. Before training in this phase of the attack, however, squads should be familiar with the overall planning and conduct of a night attack.

- (1) *Planning.* The difficulties of a night attack are overcome by careful planning and preparation, and *thorough training* in night operations. Normally more time is required to plan and coordinate a night attack than a daylight attack.
- (2) *Preparation.* Preparation for the night attack is generally the same as

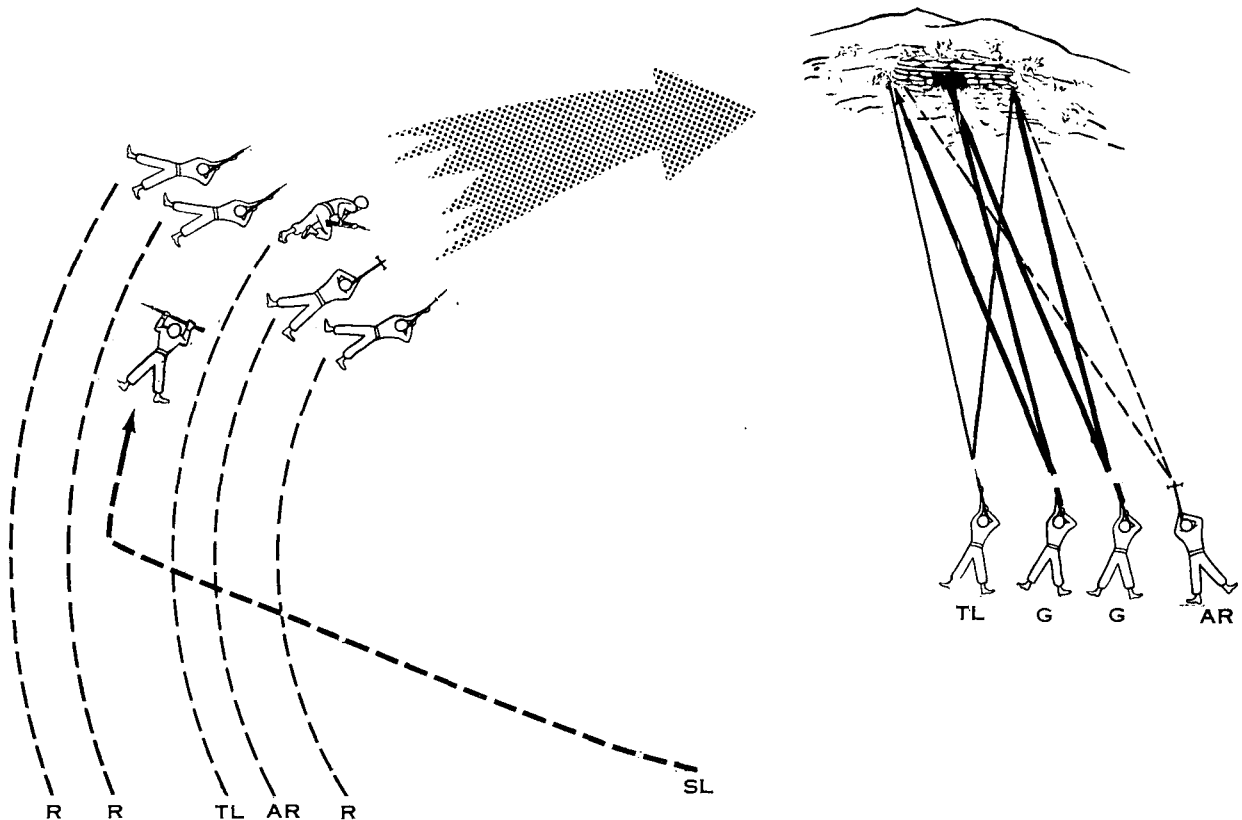


Figure 74. Distribution of fire while employing fire and movement (maneuver left; OR right).

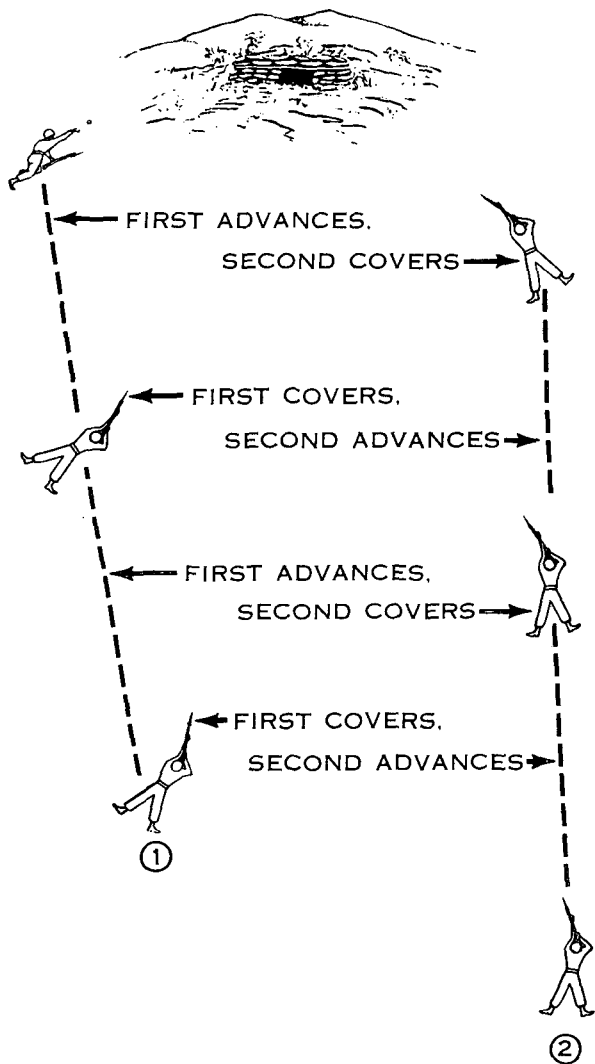


Figure 75. Individual fire and movement.

for the daylight attack. Special emphasis is placed on—

- (a) Rehearsals conducted both during daylight and darkness. Rehearsals should include formations, audible and visual signals, and the actions of the squad from the assembly area to the objective.
- (b) Carrying only that equipment absolutely essential for the success of the attack. All other equipment should be left behind and arrangements made for its delivery on the objective.

- (c) Camouflaging individuals and equipment. Equipment which rattles is padded or tied down.
- (d) Avoiding test firing of weapons and unnecessary movement, or doing this in a way which will not prematurely disclose the forthcoming attack. Ammunition and magazines should be cleaned to preclude stoppages and placed in pouches in a manner that will permit rapid reloading during the assault.
- (e) Insuring that the night vision of the squad members is not destroyed prior to the attack.

(3) *Movement.* The attacking unit moves from the assembly in a column formation. Unless visibility is extremely limited, the squad moves in a squad column to facilitate deployment without excessive noise and time. If visibility is extremely limited, the squad moves in a squad file. The attacking unit crosses the line of departure at a point(s) of departure (depending on the situation and orders), and proceeds to the platoon release point. The platoon moves to the squad release point and the squads are placed under control of the squad leaders for final deployment on the PLD. Once the platoon crosses the line of departure, movement to the PLD is continuous but slow enough to permit silent movement. Enemy encountered en route to the PLD are eliminated as silently as possible.

*e. The Assault.* On order, the squad, as part of the platoon, moves forward *silently* from the PLD, maintaining the line formation and guiding on the base squad. When the attack is discovered, assault fires are initiated. The authority to initiate assault fire is normally delegated to platoon leaders. *Scattered fire by small elements of enemy must not be taken as loss of surprise and should not be the signal to start the assault fires.* The importance of developing a great volume of fire during the assault can-



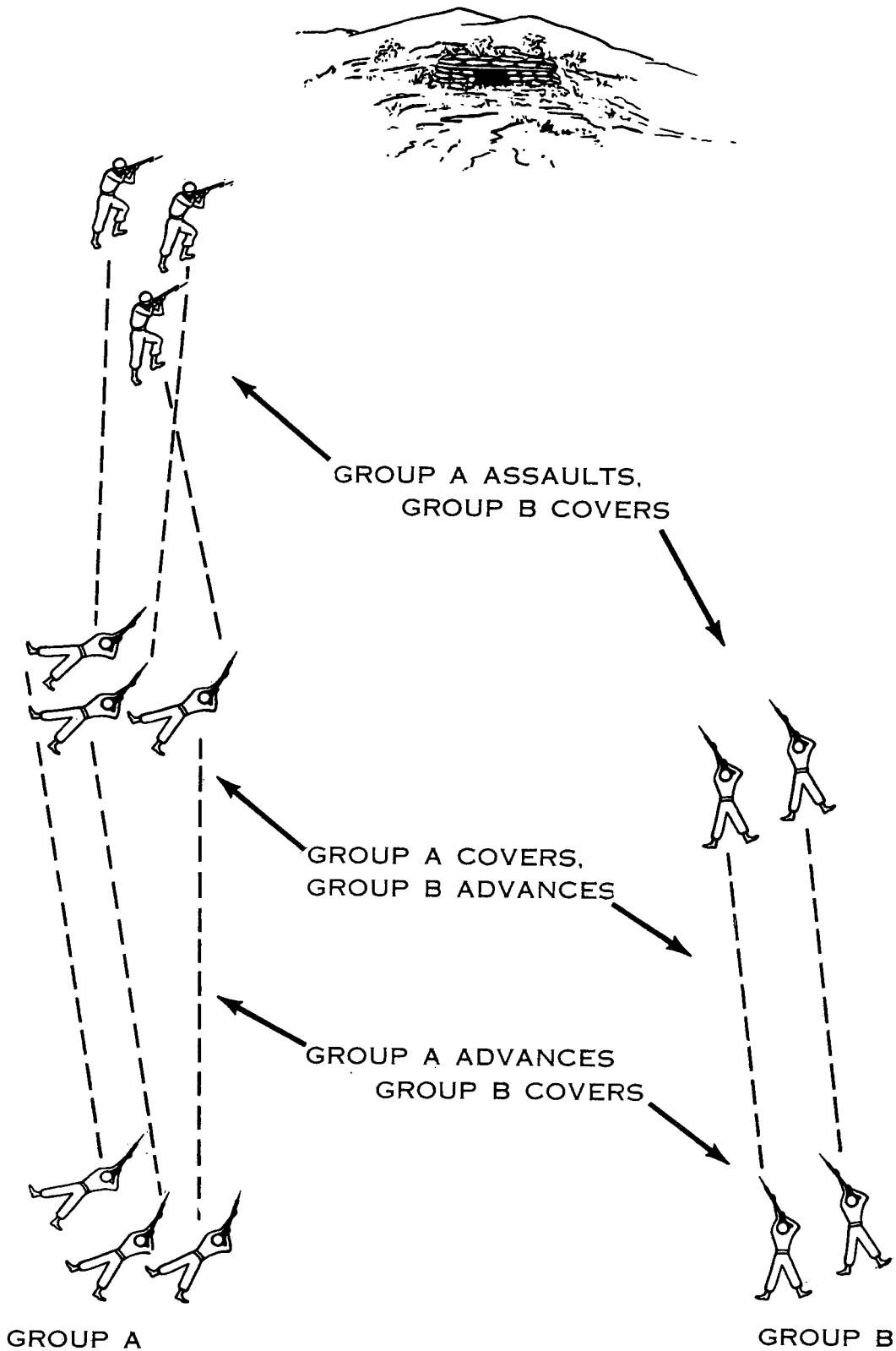


Figure 76. Group fire and movement.

not be overemphasized. It is at this time that fire superiority must be established and maintained. The assault is conducted aggressively. Troops shout and create as much noise as possible. The assault continues to the military crest on the far side of the objective.

*f. Consolidation and Reorganization.* When the objective has been seized, the plans for reorganization and consolidation are carried out as described in paragraph 88e. Elements do not move forward of the *phase line* (fig. 35), which marks the limit of advance.

## APPENDIX I

### REFERENCES

---

- AR 320-5 Dictionary of United States Army Terms.
- AR 320-50 Authorized Abbreviations and Brevity Codes.
- AR 385-63 Regulations for Firing Ammunition for Training, Target Practice, and Combat.
- FM 5-25 Explosives and Demolitions.
- FM 7-15 Infantry, Airborne Infantry, and Mechanized Infantry, Rifle Platoons and Squads.
- FM 21-5 Military Training.
- FM 21-6 Techniques of Military Instruction.
- FM 21-26 Map Reading.
- FM 21-60 Visual Signals.
- FM 21-75 Combat Training of the Individual Soldier and Patrolling.
- FM 23-8 U.S. Rifle 7.62-mm, M14.
- FM 23-30 Grenades and Pyrotechnics.
- FM 23-71 Rifle Marksmanship Course; Trainfire I.
- TC 23-3 Grenade Launchers, XM79 and T148E2.
- TM 9-855 Targets, Target Material, and Training Course Lay-outs.
- TM 9-1005-206-12 Operation and Organizational Maintenance: Caliber .22 Rifle M13, Remington Rifle M513T, Stevens Rifle M416-2T, and Winchester Rifle M75T.
- TM 9-1010-205-12 Operator and Organizational Maintenance Manual: 40-mm Grenade Launcher M79.
- TM 9-1305-200 Small-Arms Ammunition.
- TM 9-1903 Care, Handling, Preservation and Destruction of Ammunition.
- TM 9-6920-203-12P Operator's and Organizational Maintenance Repair Parts and Special Tools List: Mechanism, Target Holding (Trainfire) M31 and M31A1.
- TM 9-6920-203-34 Field Maintenance Manual: Target Holding Mechanisms (Trainfire) M31 and M31A1.
- TM 9-6920-203-34P Field Maintenance Repair Parts and Special Tools List for Target Holding Mechanisms (Trainfire) M31 and M31A1.
- TM 10-1101 Petroleum-Handling Operations.
- ATP 7-16 Headquarters and Headquarters Company, Infantry, Airborne Infantry, and Mechanized Infantry Battalions.
- ATP 7-18 Rifle Company, Infantry, Airborne and Mechanized Division, Infantry Battalions; Light Weapons Infantryman; Heavy Weapons Infantryman.
- ATP 21-114 Male Military Personnel Without Prior Service.
- ASubjScd 7-2 Rifle Squad Tactical Training.
- ASubjScd 23-24 Technique of Fire of the Rifle Squad During Periods of Limited Visibility.
- ASubjScd 23-36 Daytime Technique of Fire of the Rifle Squad.
- DA Pam 108-1 Index of Army Motion Pictures, Film Strips, Slides and Phono-Recordings.
- DA Pam 310-3 Index of Training Publications.
- DA Pam 310-4 Military Publications: Index of Technical Manuals, Technical Bulletins; Supply Bulletins, Lubrication Orders, and Modification Work Orders.

## APPENDIX II

### AMMUNITION REQUIREMENTS

This appendix provides a recapitulation of ammunition requirements for technique of fire training. Ammunition listed below for these exercises is not to be construed as a mandatory requirement for the conduct of the exercises but is furnished as a guide to be used in conjunction with established allowances in TA 23-100. Unit commanders will insure that ammunition expended for the exercises will in no instance exceed authorized allowances in TA 23-100.

#### 1. Ammunition Requirements for Two Field Target Firing Exercises

(par. 33b)

Individual weapon	Rounds per individual	Type of ammunition
M14 Rifle-----	50	Ctg, TR, 7.62-mm.
M14 Rifle Modified----	140	Ctg, TR, 7.62-mm.
M79 Grenade Launcher.	8	Ctg, 40-mm HE or Prac.

*Notes.*

1. Riflemen fire five magazines containing five rounds each, and automatic riflemen fire seven magazines containing 10 rounds each per exercise.
2. Range facilities determine the use of HE or Practice 40-mm rounds.
3. The M79 Grenade Launcher and the automatic rifle are not used during basic combat training. All weapons are used when field target firing is conducted in advanced individual or basic unit training.

#### 2. Ammunition Requirements for Four Landscape Target Firing Exercises

(par. 37a)

*a. Zeroing.*

Squad member	Individual weapon	Rounds per individual	Type of ammunition
Team Leaders and Riflemen.	M14 Rifle---	9	Ctg, Ball 7.62-mm.
Automatic Riflemen.	M14 Rifle Modified.	9	Ctg, Ball 7.62-mm.

*b. Practical Exercises.*

Squad member	Individual weapon	Rounds per individual	Type of ammunition
Team Leaders and Riflemen.	M14 Rifle---	20	Ctg, Ball 7.62-mm.
Automatic Riflemen.	M14 Rifle Modified.	40	Ctg, Ball 7.62-mm.

*Notes.*

1. During practical exercises, riflemen and team leaders fire five rounds per exercise (target situation), and automatic riflemen fire 10 rounds per exercise (target situation).
2. If .22 caliber rifles are used, the ammunition allocation is the same.
3. The automatic rifle is not used during basic combat training. The automatic rifle should be used during advanced individual or basic unit training.

#### 3. Squad Defensive Night Firing

*a. Ammunition Requirements for Three Instruction Firing Exercises (par. 49b).*

Individual weapon	Rounds per individual	Type of ammunition
M14 Rifle-----	24	Ctg, Ball 7.62-mm.
M14 Rifle Modified----	60	Ctg, Ball 7.62-mm.
M79 Grenade Launcher.	9	Ctg, 40-mm Prac.

*Notes.*

1. Team leaders and riflemen fire one magazine containing eight rounds each, and automatic riflemen fire one magazine containing 20 rounds per exercise during instruction firing.
2. Grenadiers fire three rounds of practice ammunition per exercise during instruction firing.

*b. Ammunition Requirements for One Application Firing or One Proficiency Firing Exercise (par. 51c).*

Individual weapon	Rounds per individual	Type of ammunition
M14 Rifle-----	30	Ctg, Ball 7.62-mm.
M14 Rifle Modified-----	80	Ctg, Ball 7.62-mm.
M79 Grenade Launcher.	10	Ctg, 40-mm Prac.

*Notes.*

1. Riflemen fire six magazines containing five rounds each per exercise during application firing. Automatic riflemen fire one 20-round magazine for practice prior to the exercise and three 20-round magazines during the exercise.
2. Range facilities determine whether HE or Practice 40-mm rounds are used during application firing.
3. During proficiency firing, the control officer has the option of permitting the automatic riflemen to fire one 20-round magazine for practice. If they do not fire one magazine for practice, their ammunition allocation is 60 rounds.

**4. Squad Assault Night Firing**

*a. Ammunition Requirements for One Ball and One Tracer Instruction Firing Exercise (par. 64b).*

*(1) Ball ammunition exercise.*

Individual weapon	Rounds per individual	Type of ammunition
M14 Rifle-----	24	Ctg, Ball 7.62-mm.
M14 Rifle Modified-----	60	Ctg, Ball 7.62-mm.
M79 Grenade Launcher.	3	Ctg, 40-mm Prac.

*(2) Tracer ammunition exercise.*

Individual weapon	Rounds per individual	Type of ammunition
M14 Rifle-----	24	Ctg, TR, 7.62-mm.
M14 Rifle Modified-----	60	Ctg, TR, 7.62-mm.
M79 Grenade Launcher.	3	Ctg, 40-mm Prac.

*Notes.*

1. Riflemen fire three magazines containing eight rounds each per exercise.
2. Automatic riflemen fire three magazines containing 20 rounds each per exercise.
3. Expended grenade cartridges may be substituted for practice ammunition during ball ammunition exercises.

*b. Ammunition Requirements for One Application Firing or One Proficiency Course Exercise (par. 66d).*

Individual weapon	Rounds per individual	Type of ammunition
M14 Rifle-----	30	Ctg, TR, 7.62-mm.
M14 Rifle Modified-----	60	Ctg, TR, 7.62-mm.
M79 Grenade Launcher.	3	Ctg, 40-mm Prac.

*Notes.*

1. Team leaders and riflemen fire three magazines containing ten rounds each per exercise.
2. Automatic riflemen fire three magazines containing 20 rounds each per exercise.

## APPENDIX III

### SAFETY

---

#### 1. General

This appendix covers the safety precautions used to insure safe conditions on the ranges described in this manual. These safety precautions will assist the instructor in meeting the safety requirements for conduct of this training. They are intended as a guide only and must be used in conjunction with those listed in Army and local regulations.

#### 2. General Safety Precautions

The following safety precautions are recommended for all live firing prescribed in this manual:

*a.* A red streamer will be displayed at the entrance or from a prominent location on the range during all firing. At night, a blinking red light is used in addition to the streamer.

*b.* Prior to firing, all individuals will be shown the firing limits of the range and will be required to keep fires within them.

*c.* During daylight hours, firing limits will be indicated by red and white striped poles visible to all firers. At night, firing limits are marked by two red lights mounted on poles visible to all firers.

*d.* No firing will be conducted until the area has been sealed off by the prescribed roadblocks, barriers, or necessary range guards.

*e.* Prior to firing, the officer in charge (OIC) will insure qualified medical personnel are located on the range or in an area where they can be contacted quickly.

*f.* Prior to firing, all weapons will be checked by an officer or noncommissioned officer to insure that there are no obstructions in the bores. All weapons drawn from a weapons pool will be test fired before troops are permitted to fire them.

*g.* Steel helmets will be worn by all personnel on or forward of the firing line for all live firing exercises.

*h.* Ammunition will be drawn or issued only on command of the OIC.

*i.* Weapons will be kept in a prescribed area, locked with bolts open when not in use.

*j.* Weapons will be loaded and unlocked only on command of the OIC.

*k.* Weapons will not be pointed at anyone. They are always treated as if they are loaded.

*l.* Weapons will not be removed from the firing line until they have been cleared by safety personnel.

*m.* No smoking is permitted on the range near any ammunition, explosives, or flammables. See TM 9-1903 and TM 10-1101.

*n.* No one will move forward of the firing line without the permission of the OIC.

*o.* Anyone observing an unsafe condition will give the command CEASE FIRE. If the command is given, it will be relayed to the OIC who will repeat the command and investigate the condition before firing is resumed.

*p.* After firing, all weapons will be inspected by safety personnel to insure they are clear and a check will be conducted to determine if any brass or unexpended ammunition is in the possession of troops.

*q.* All duds will be clearly marked. If the duds cannot be located, the area will be clearly marked and reported in accordance with local regulations.

*r.* AR 385-63 will be followed when demolitions are used during the exercise.

#### 3. Safety Precautions for the Grenade Launcher (M79)

*a.* Safety precautions as specified in TC 23-3 and AR 385-63 the firing of ammunition types

M381 and M406 high explosive and M382 and M407 practice.

b. These safety precautions will not permit the grenade launcher to be used in the conduct of squad assault night firing as described in this manual. The grenade launcher can be used during squad defensive night firing only when special targets can be set up at ranges specified in AR 385-63.

c. The grenade launcher will be employed only when the following safety requirements are met:

- (1) All personnel, unless protected, must be outside the danger area. See AR 385-63.
- (2) Overhead firing is not permitted unless personnel in the danger area are protected. Minimum protection is a bunker or similar shelter constructed to withstand a direct hit without injury to personnel inside (fig. 94).
- (3) No vegetation or growth which might activate the fuze may exist within 80 meters forward of the firing position.
- (4) Ground winds are less than 30 miles per hour.

d. Careful consideration must be given to duds which will accumulate during firing. The impact area must be kept free of heavy vegetation to facilitate the location and destruction of duds. Personnel must be cautioned not to disturb or step on duds.

e. The ammunition listed in *a* above are interim types. Ammunition presently under development is not expected to require such restrictive safety precautions, and should permit employment of the grenade launcher during all live firing exercises described in this manual. Specifications of future ammunition and its related safety precautions will be published by the appropriate technical service as the ammunition is made available for issue.

f. Due to the state of development of the grenade launcher ammunition, related safety precautions will change periodically. Therefore, it is extremely important for the officer in charge of firing to insure that the safety precautions being followed are appropriate for the type of ammunition being used.

#### 4. Field Target Firing

a. Individuals will load only when in the prone position on the firing line.

b. Squads will not be permitted on the firing line until a clearance has been received from the personnel pits.

c. All personnel performing range details forward of the firing line will have a red flag in their possession. This flag will be displayed any time the down range personnel are not in personnel pits.

d. When the command CEASE FIRE is given, or if a red range flag appears down range, all weapons will be locked, unloaded, and cleared.

e. Down range personnel will not leave the pits, attempt to score, remove or replace targets, or repair devices until clearance has been received from the OIC.

f. Individuals moving on the firing line during the conduct of an exercise will leave their weapons in place unless they have been cleared by safety personnel.

g. A minimum of two safety noncommissioned officers (NCO's) will be utilized on the firing line during the conduct of an exercise.

#### 5. Landscape Target Firing

a. Individuals will load only when in the prone position on the firing line.

b. Personnel scoring, marking, or replacing or repairing landscape targets will not move forward of the firing line until clearance has been received from the OIC.

c. Individuals moving on the firing line during the conduct of an exercise will leave their weapons on their points unless they have been cleared by safety personnel.

#### 6. Squad Defensive Night Firing and Proficiency Firing Course

a. Before moving a squad onto the firing line, the OIC will clear the range by announcing loudly, twice, "IS THERE ANYONE DOWN RANGE?"

b. Squads will not move onto the firing line until ordered to do so by the OIC.

c. A minimum of four safety NCO's will be utilized on the firing line to issue ammunition and guard against any unsafe acts during the conduct of the exercises.

d. If the squad leader moves along the firing line, his weapon will be grounded.

e. Ammunition not fired during the exercise will be collected by the Safety NCO's.

f. When the command CEASE FIRE has been given, all firers will clear their weapons. The safety NCO's will insure that all weapons area clear.

g. A verbal report that all weapons on his firing points have been cleared will be given by the safety NCO to the OIC at the completion of each exercise.

h. Individuals will remain in position until directed to leave the firing line by the OIC.

i. An officer or NCO in charge of the scoring detail will report to the OIC when all the scoring detail has returned to the firing line.

## **7. Squad Assault Night Firing and Proficiency Course**

a. Before moving the squad onto the starting line, the OIC will clear the range by announcing loudly, twice, "IS THERE ANYONE DOWN RANGE?"

b. No one will move onto or forward of the starting line until ordered to do so by the OIC.

c. The squad leader will not give the command to fire until the targets are activated.

d. Automatic riflemen are restricted to firing on one-half the target area. A single red light

is placed in the center and above the target area to divide it. This light is pointed out to all squad members as a safety factor.

e. Each firer will be accompanied by a safety NCO. If any of the following conditions occur, the safety NCO will declare the firer a casualty and instruct him to lock his weapon, point it in the air, and continue moving to the cease fire line.

- (1) The firer gets too far ahead of or behind the squad.
- (2) The firer gets too close to the man on his right and left.
- (3) The firer shoots wildly.
- (4) The firer stops for any reason.

f. If the firer falls or stumbles, the safety NCO will secure the weapon, lock and point it in the air, and direct the firer to continue moving to the cease fire line.

g. If a weapon fails to fire, the firer will continue to move while applying immediate action.

h. The OIC will halt the squad at the cease fire line by blowing a whistle. At the cease fire line, weapons are locked and cleared and unexpended ammunition is collected. Safety NCO's report in sequence to the OIC when their points are cleared.

i. At the completion of each firing exercise, a designated safety NCO will report to the OIC when all personnel have returned to the starting line.

j. If the whistle is blown any time during the conduct of an exercise, all firers will halt, lock and point their weapons in the air, and wait for orders from the OIC.



## APPENDIX IV TRAINING AIDS

### 1. General

Training aids should be used to the maximum during technique of fire instruction. A model, picture, or chart can be used to explain a principle or technique which would otherwise require many words. Effective training aids improve instruction and increase understanding.

### 2. Training Aids

Figures 77 through 85 illustrate the type of training aids needed to conduct technique of fire training. These training aids should not limit the instructor's imagination or replace any other aids which may be available or listed in training aids catalogs. The services of local training aids centers should be utilized wherever possible to provide by loan or fabrication the desired training aids and devices.

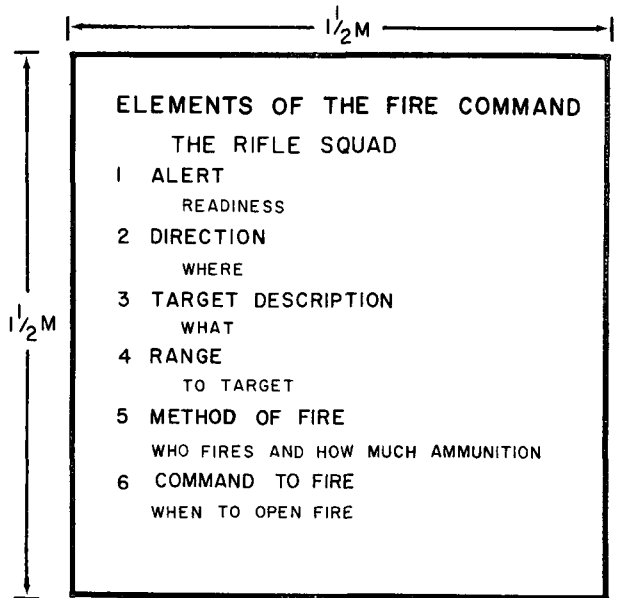


Figure 77. Chart used to teach squad fire command.

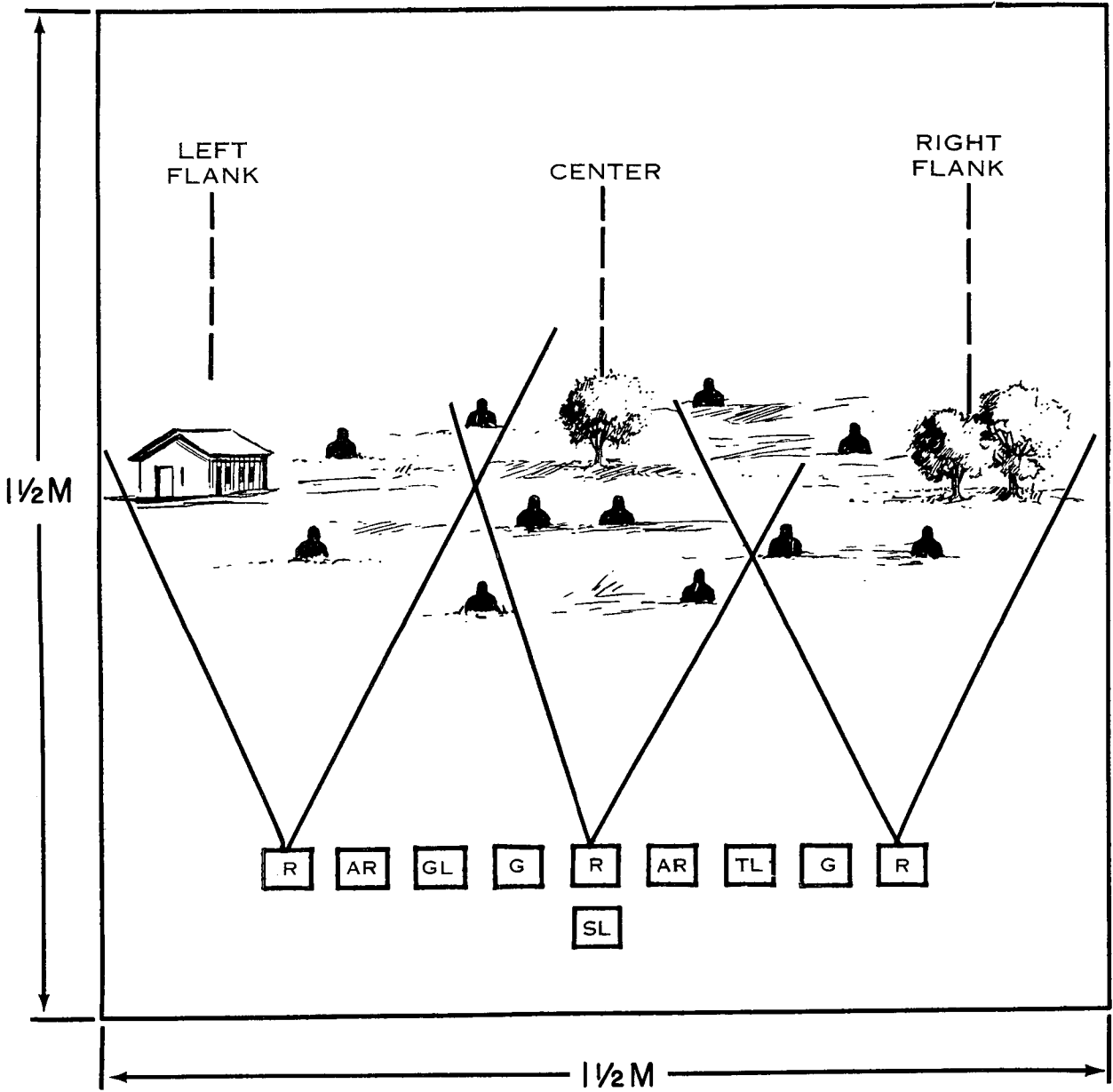


Figure 78. Chart showing distribution of fire by riflemen on a linear target.

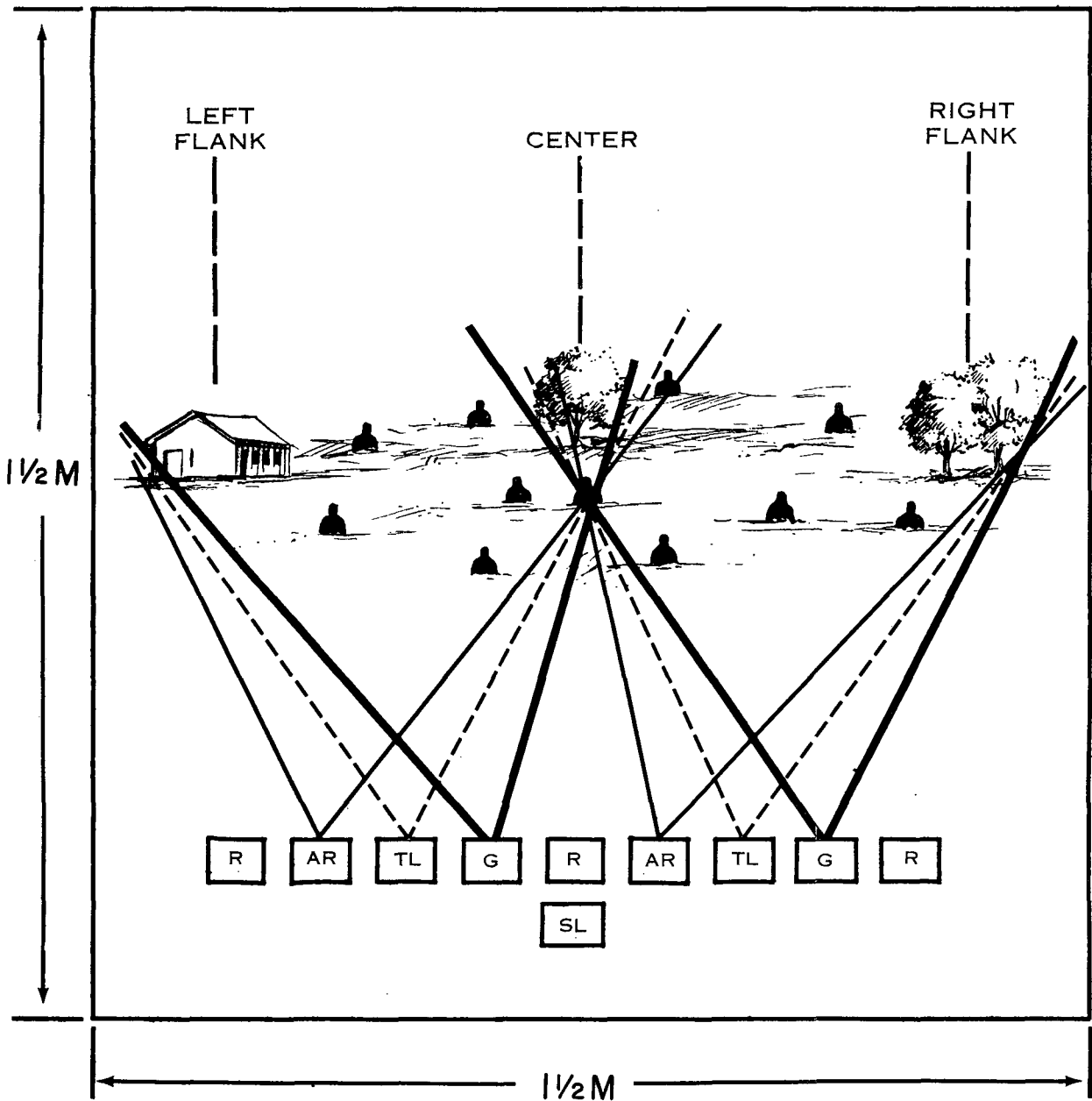


Figure 79. Chart showing distribution of fire by team leaders, automatic riflemen, and grenadiers on a linear target.

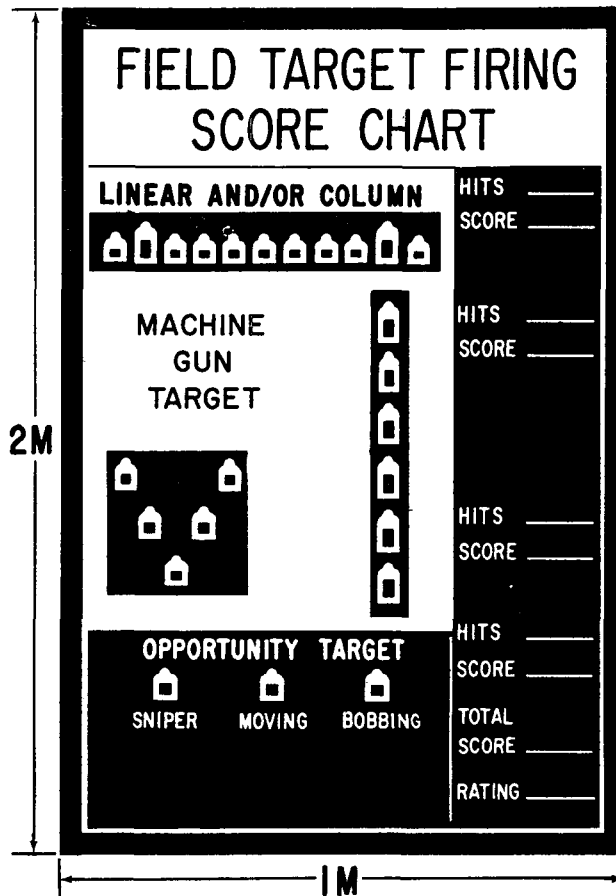


Figure 80. Field target firing score chart.

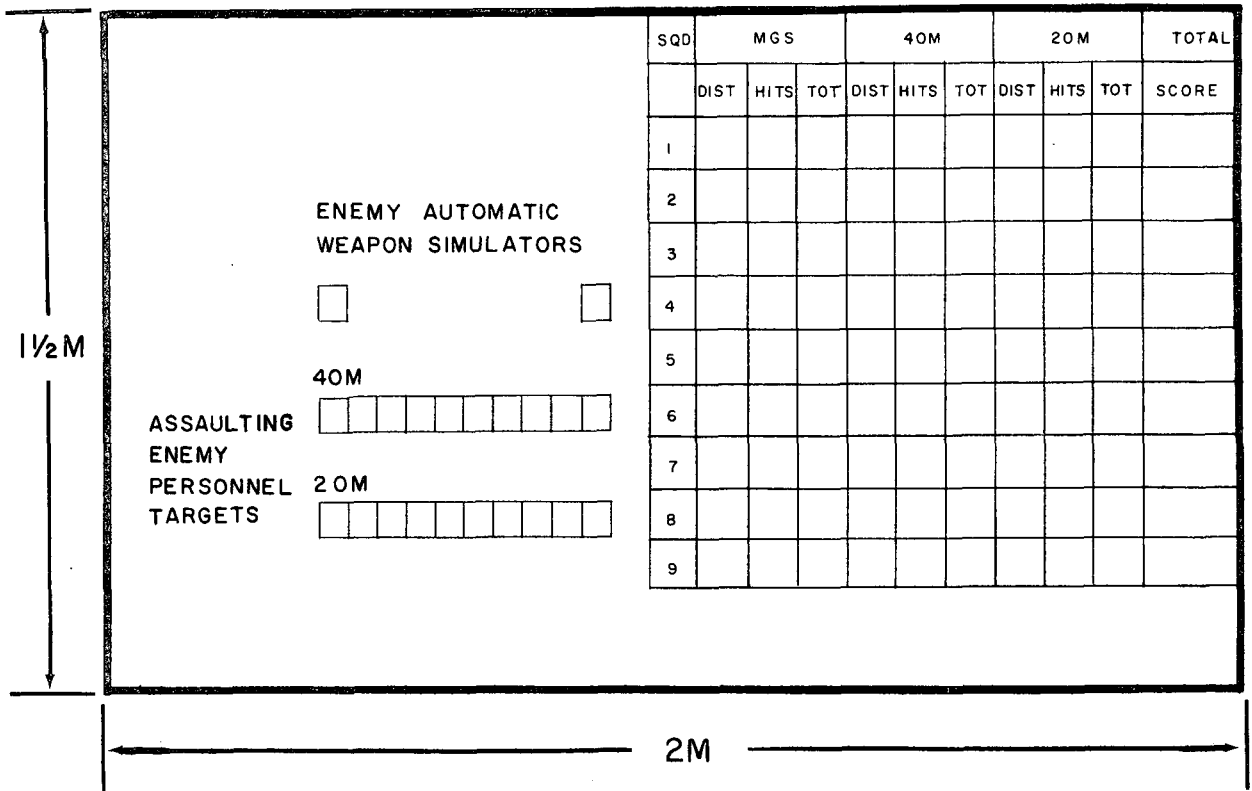


Figure 81. Squad defensive night firing score chart.

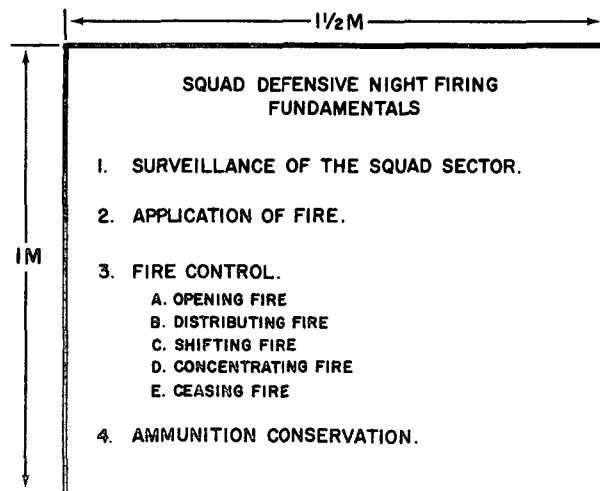


Figure 82. Squad defensive night firing critique chart.

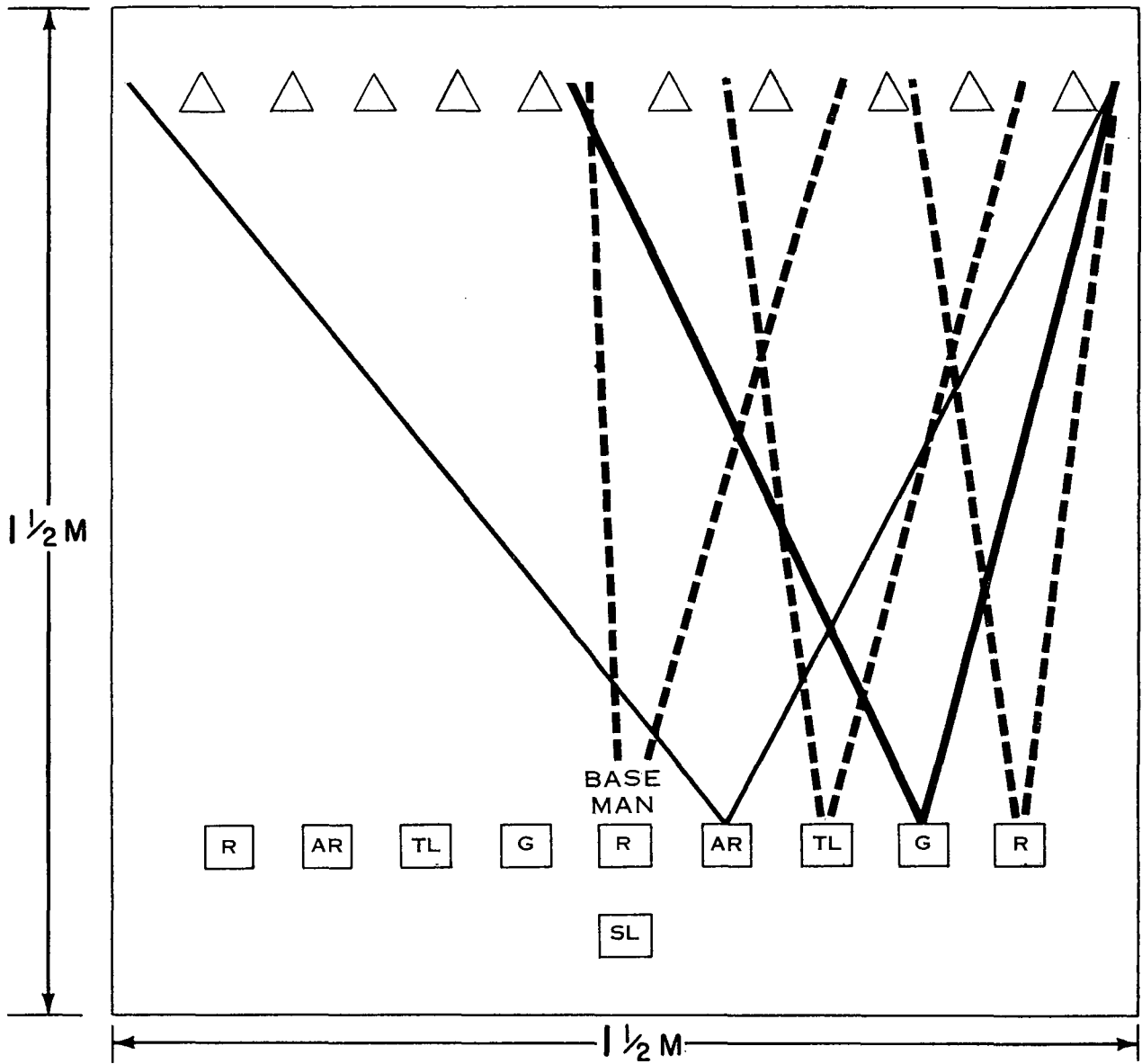


Figure 83. Chart showing distribution of fire in a night assault.

1  2  3  4  5  6  7  8  9  10  
 ROUNDS FIRED   
 TOTAL HITS   
 DISTRIBUTION SCORE   
 TOTAL SCORE

**UNIT SCORES**

SQD. NO.	RDS. FIRED	HITS	DIST.	TOTAL SCORE

Figure 84. Squad assault night firing score chart.

**NIGHT ASSAULT FIRING**

1. FIRING POSITION
2. SPEED OF MOVEMENT & MAINTENANCE OF ALIGNMENT
3. RELOADING
4. KEEPING FIRE DOWN
5. FIRE DISTRIBUTION

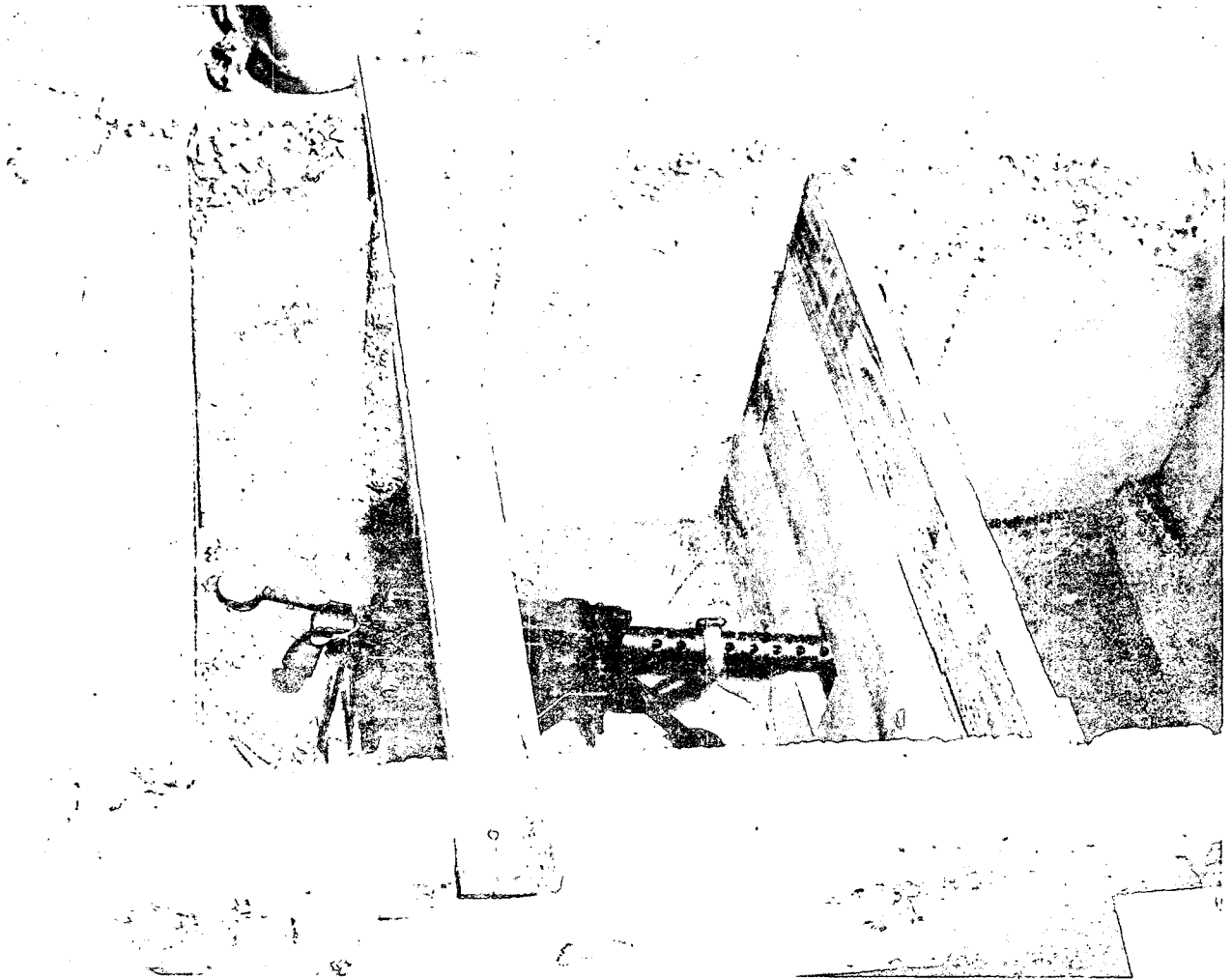
Figure 85. Squad assault night firing critique chart.

## APPENDIX V

### TRAINING DEVICES

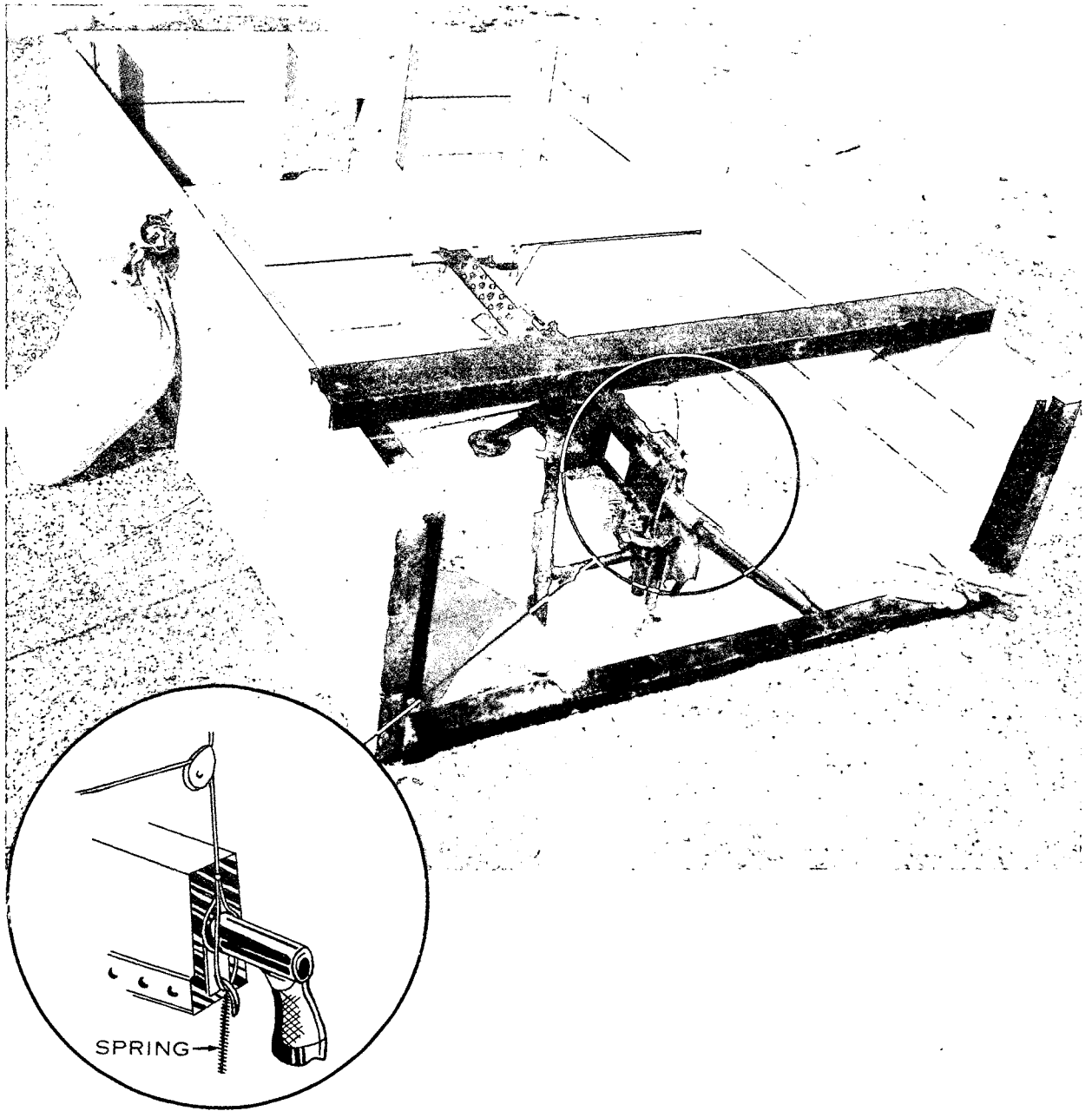
---

These illustrations (figs. 86-100) are provided as a guide for the instructor in the construction of devices required for technique of fire instruction. Other than the electrically operated targets, all devices illustrated in this appendix are relatively simple and can be easily constructed from material found at most range maintenance shops or salvage yards.

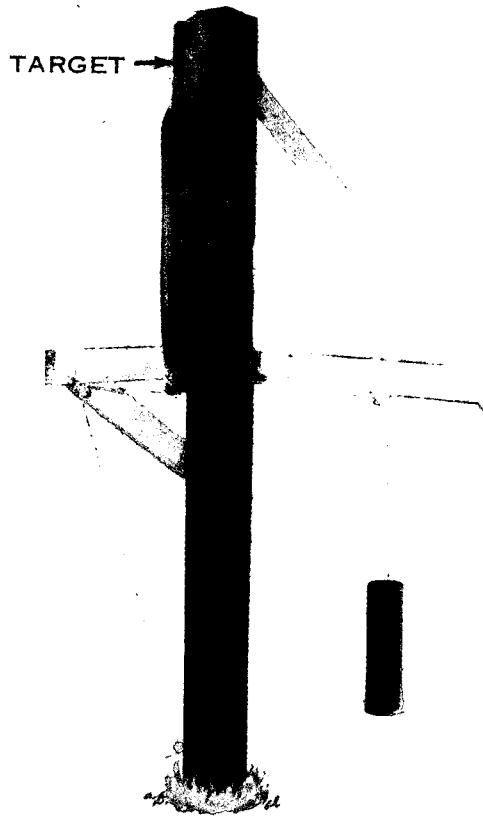


*Figure 86. Placement of machinegun in pit.*

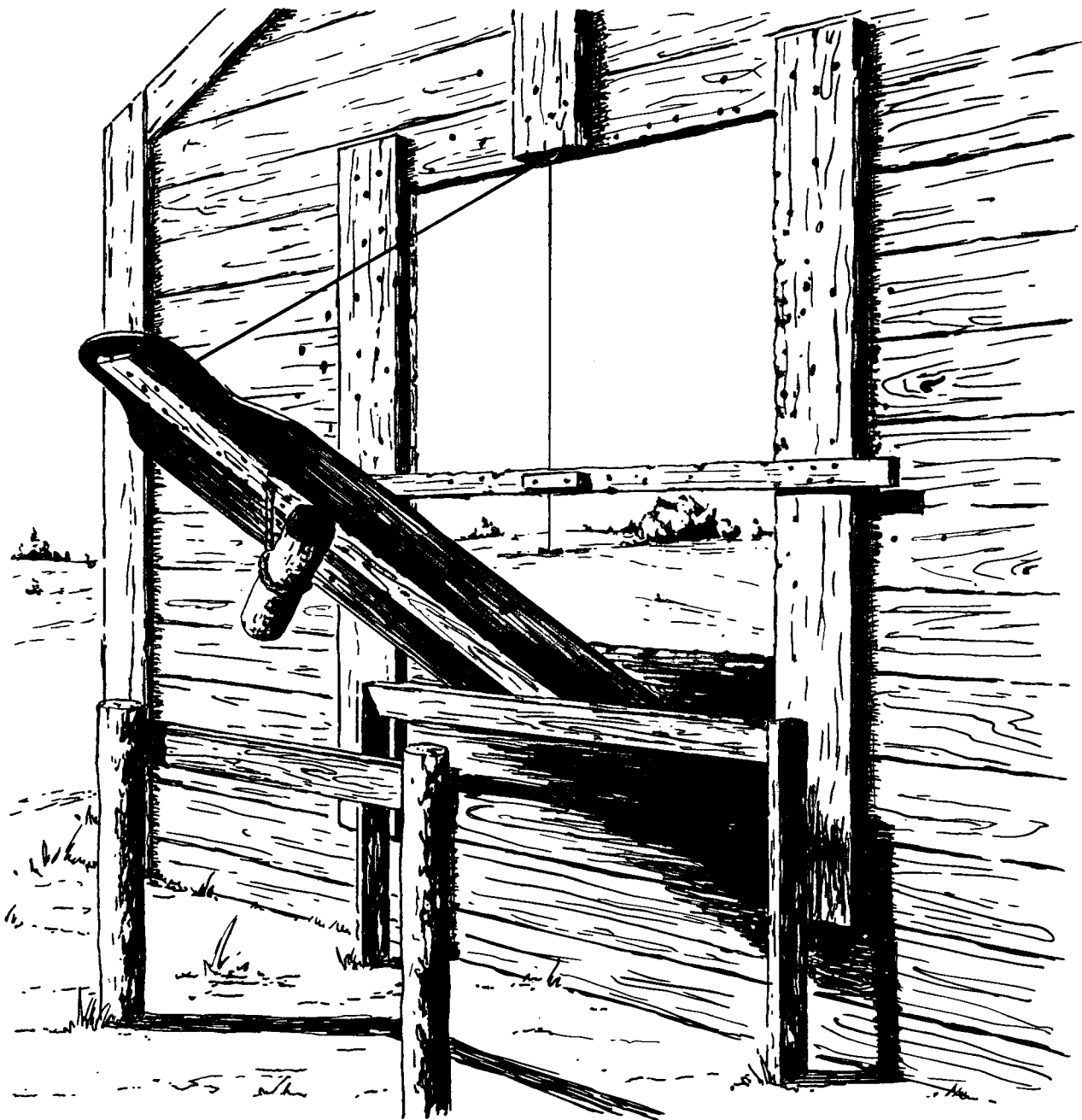




*Figure 87. Detailed cable pulley system for firing machinegun.*



*Figure 88. Sniper target mounted on a post.*



*Figure 89. A method of raising a sniper target.*

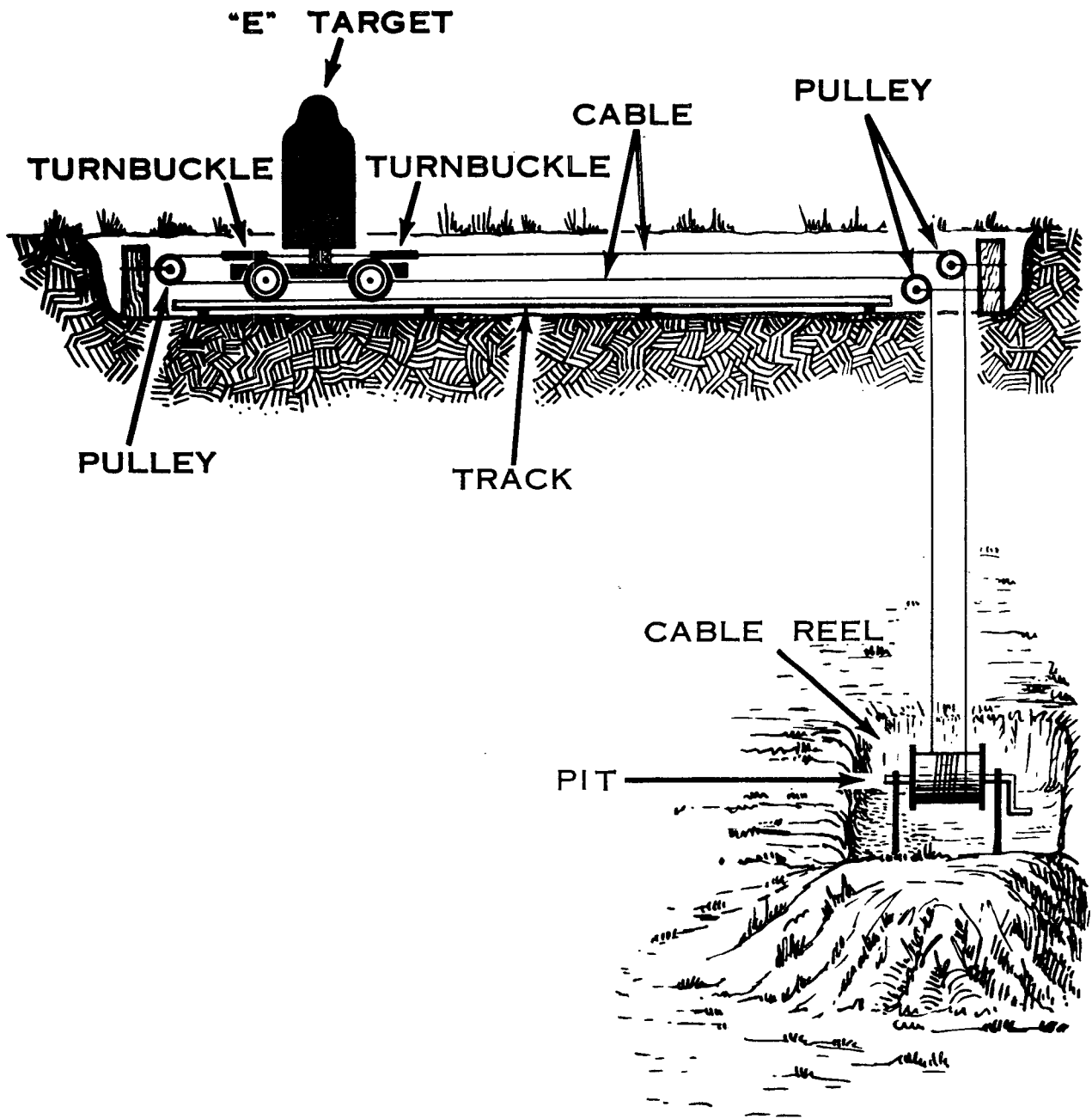
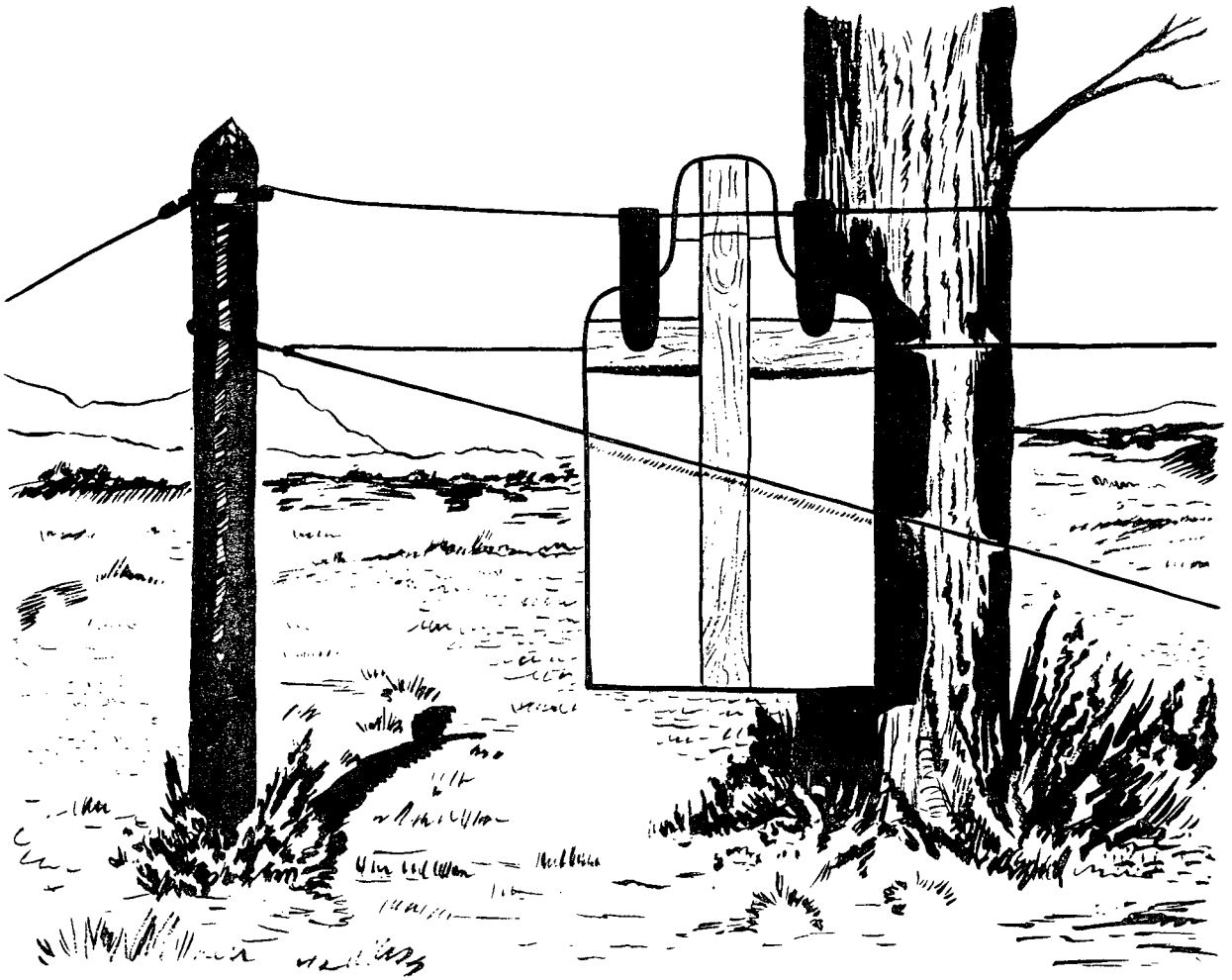


Figure 90. A moving target system.



*Figure 91. An arrangement for moving target along a horizontal line.*

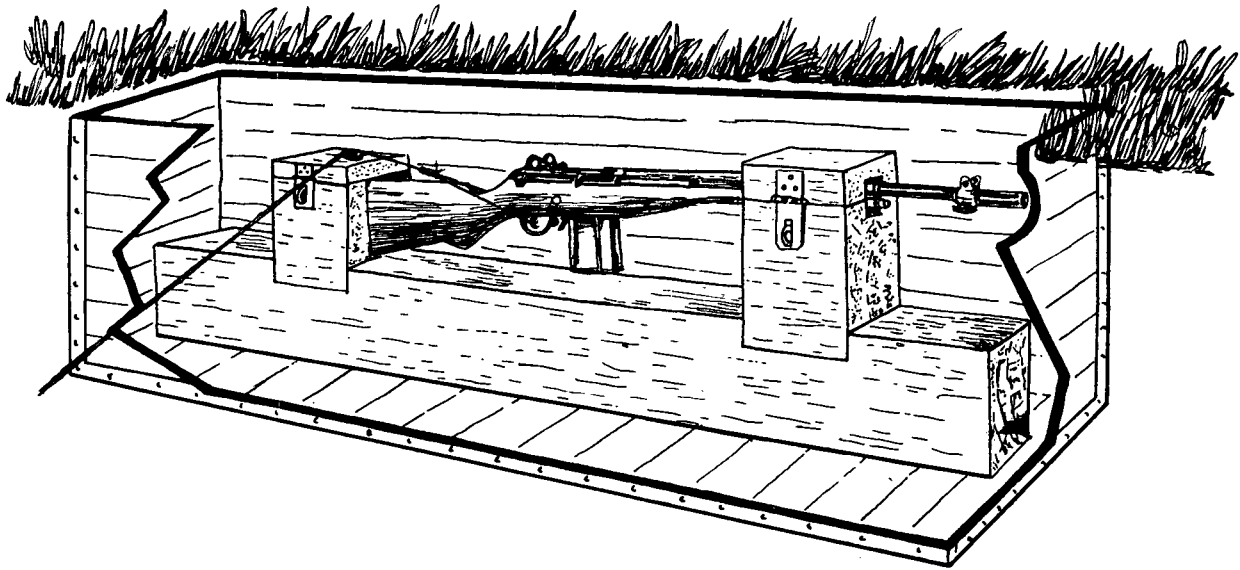


Figure 92. Rifle mount for installation in pit.

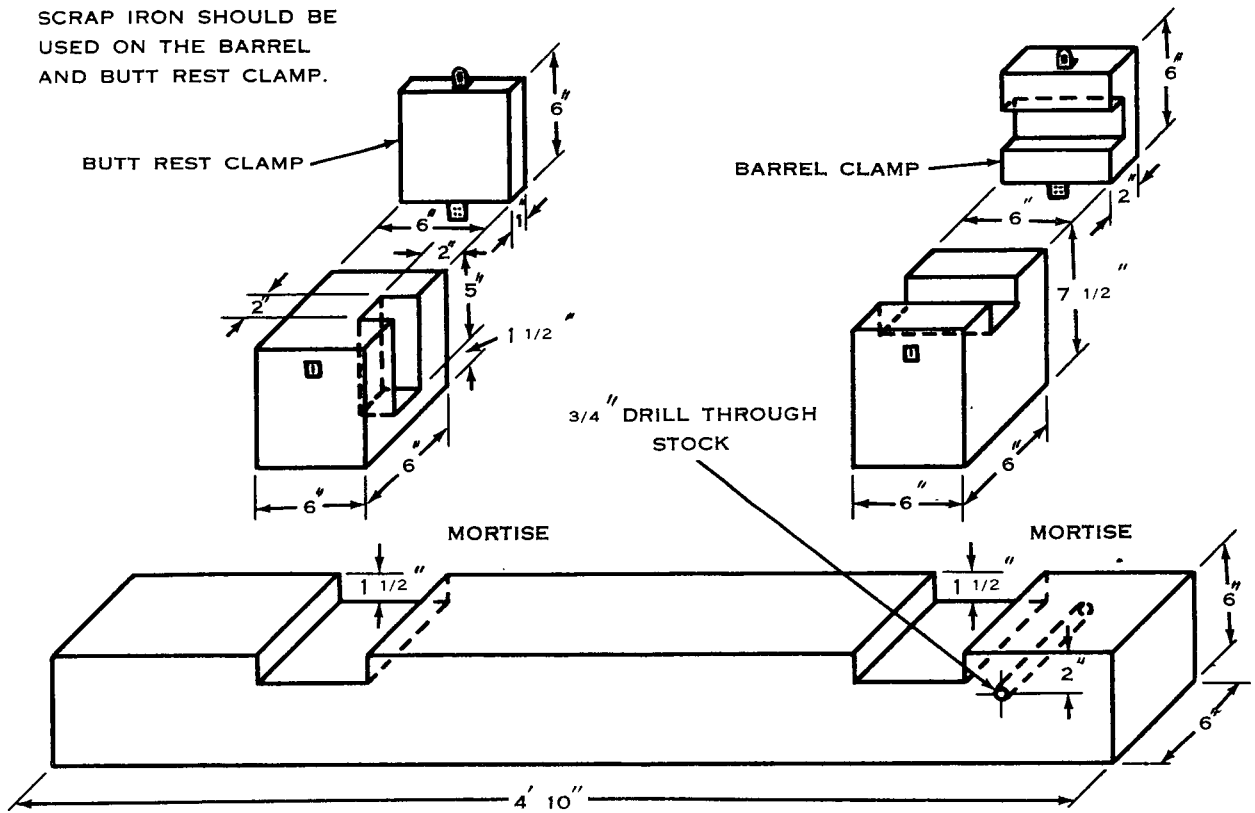
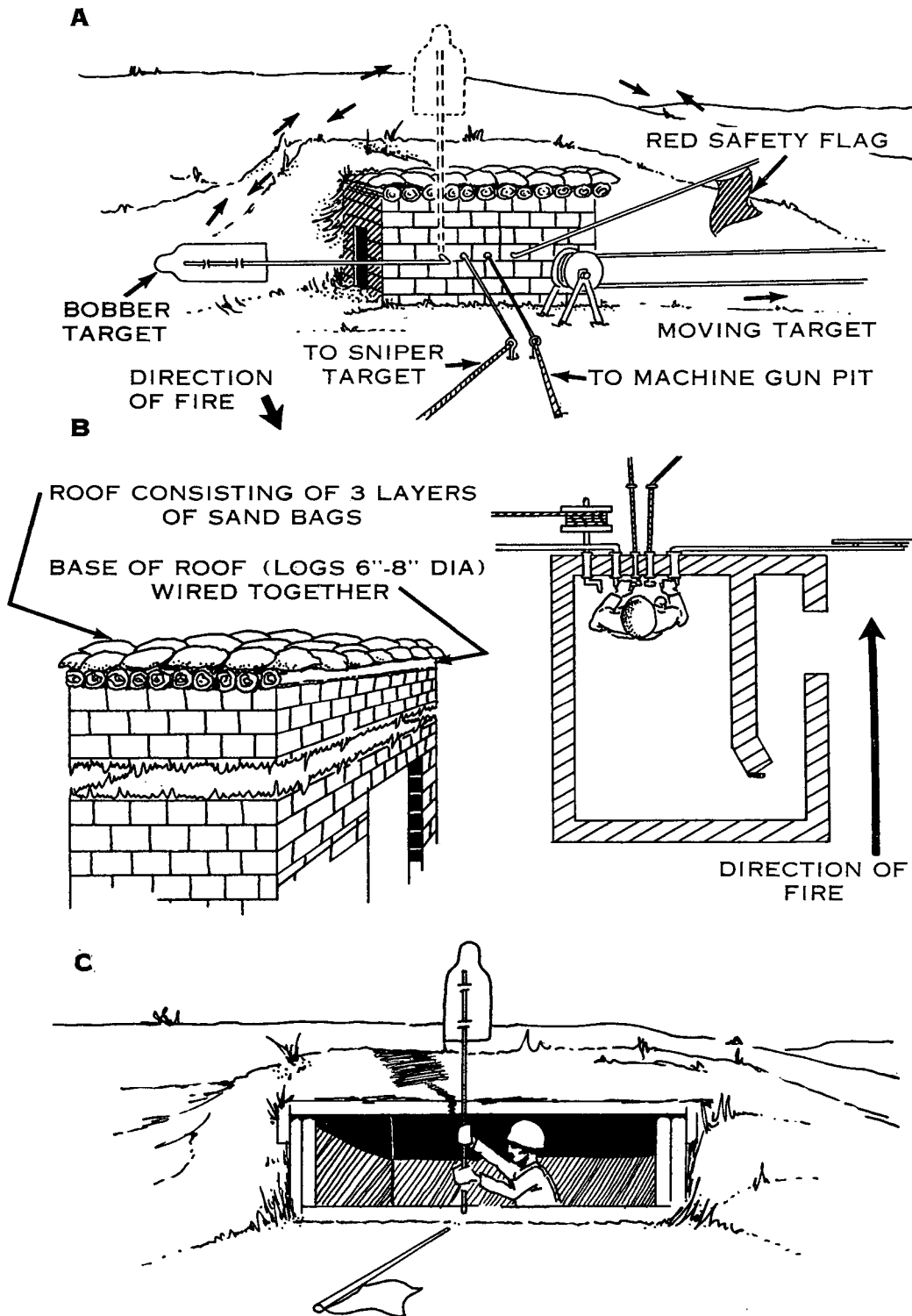


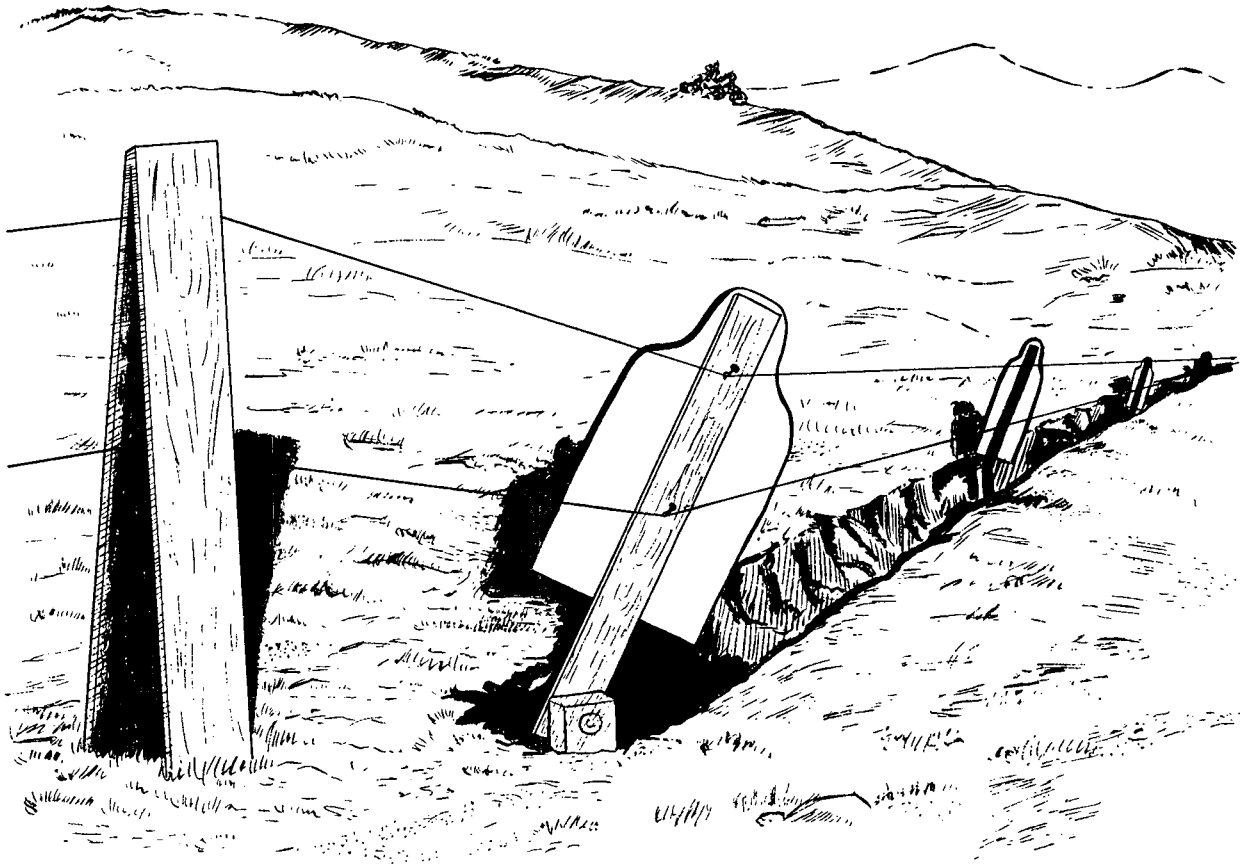
Figure 93. Rifle mount detail.



A—Outside view of a field target firing range personnel pit which must be used when grenade launchers are fired.

B—Design and inside view of a field target firing range personnel pit used when grenade launchers are fired.

C—Design of a field target firing range personnel pit which can be used when grenade launchers are not fired.



*Figure 95. A method of raising linear targets.*



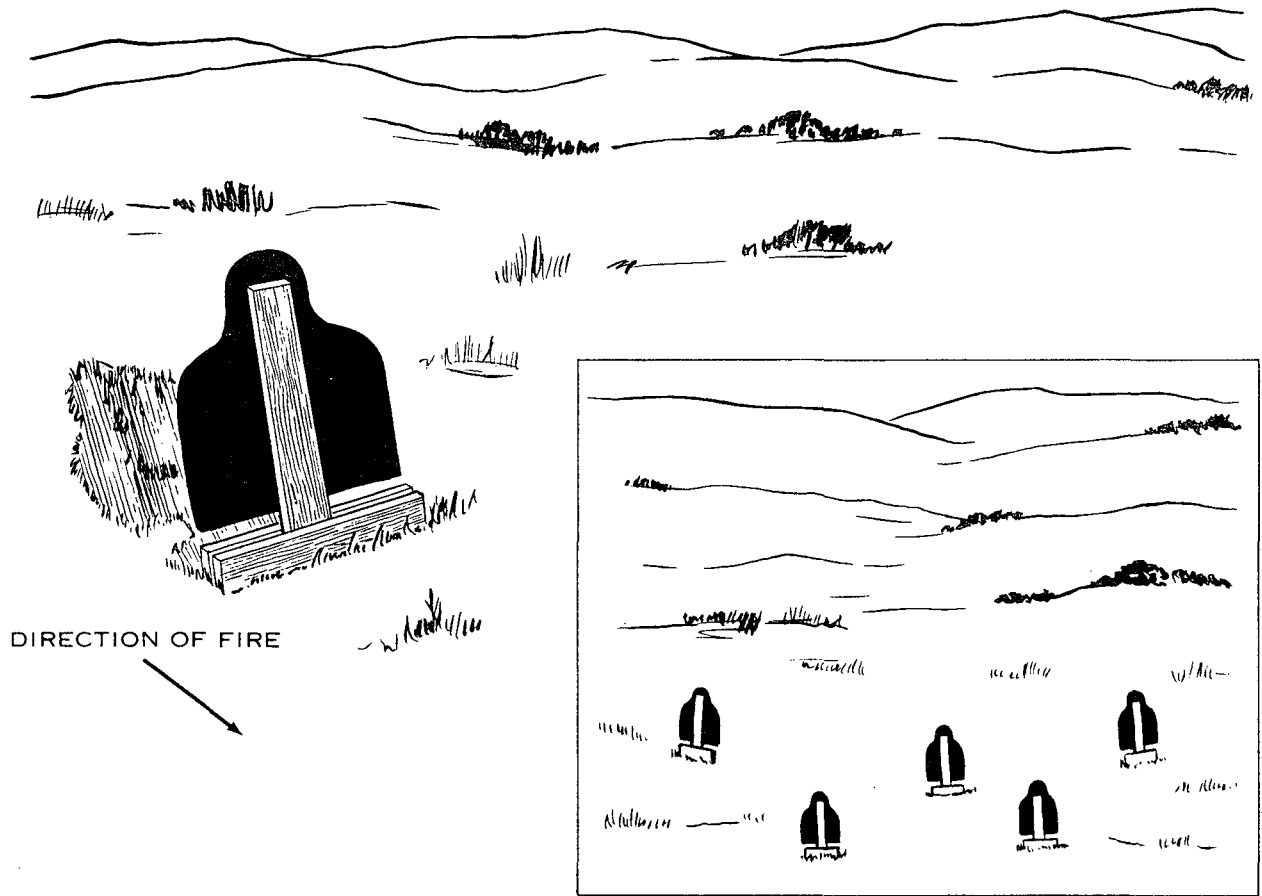
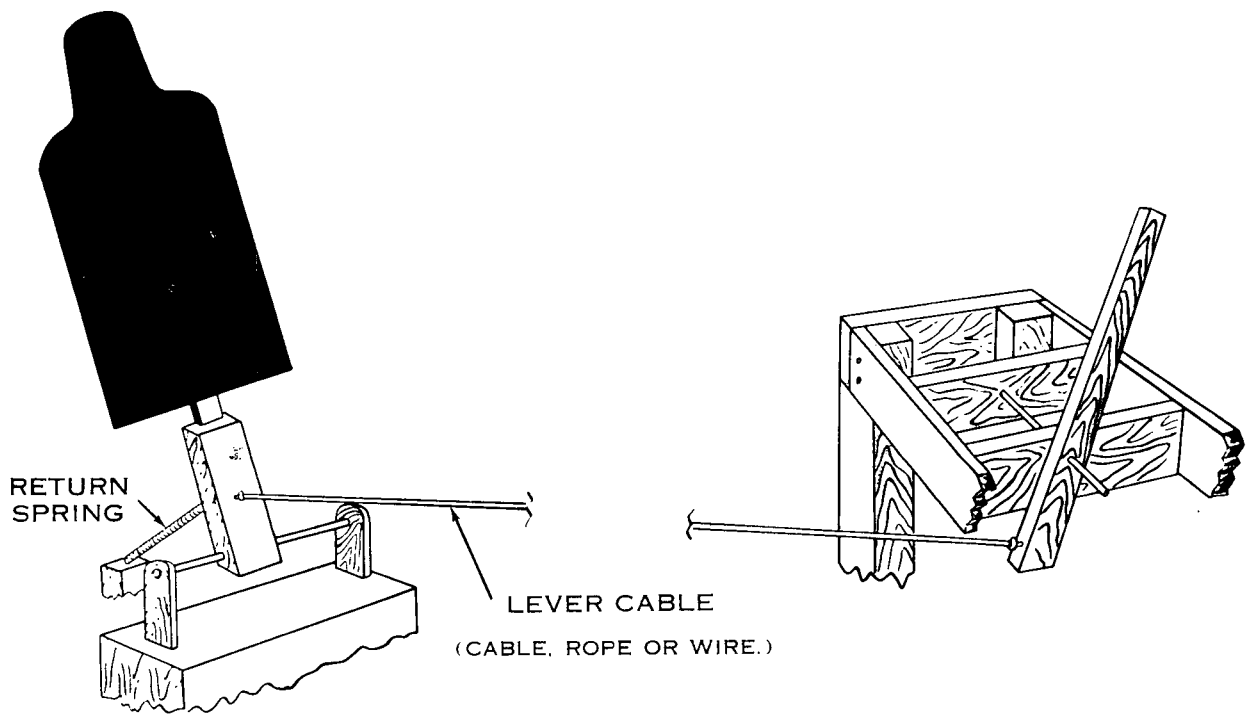
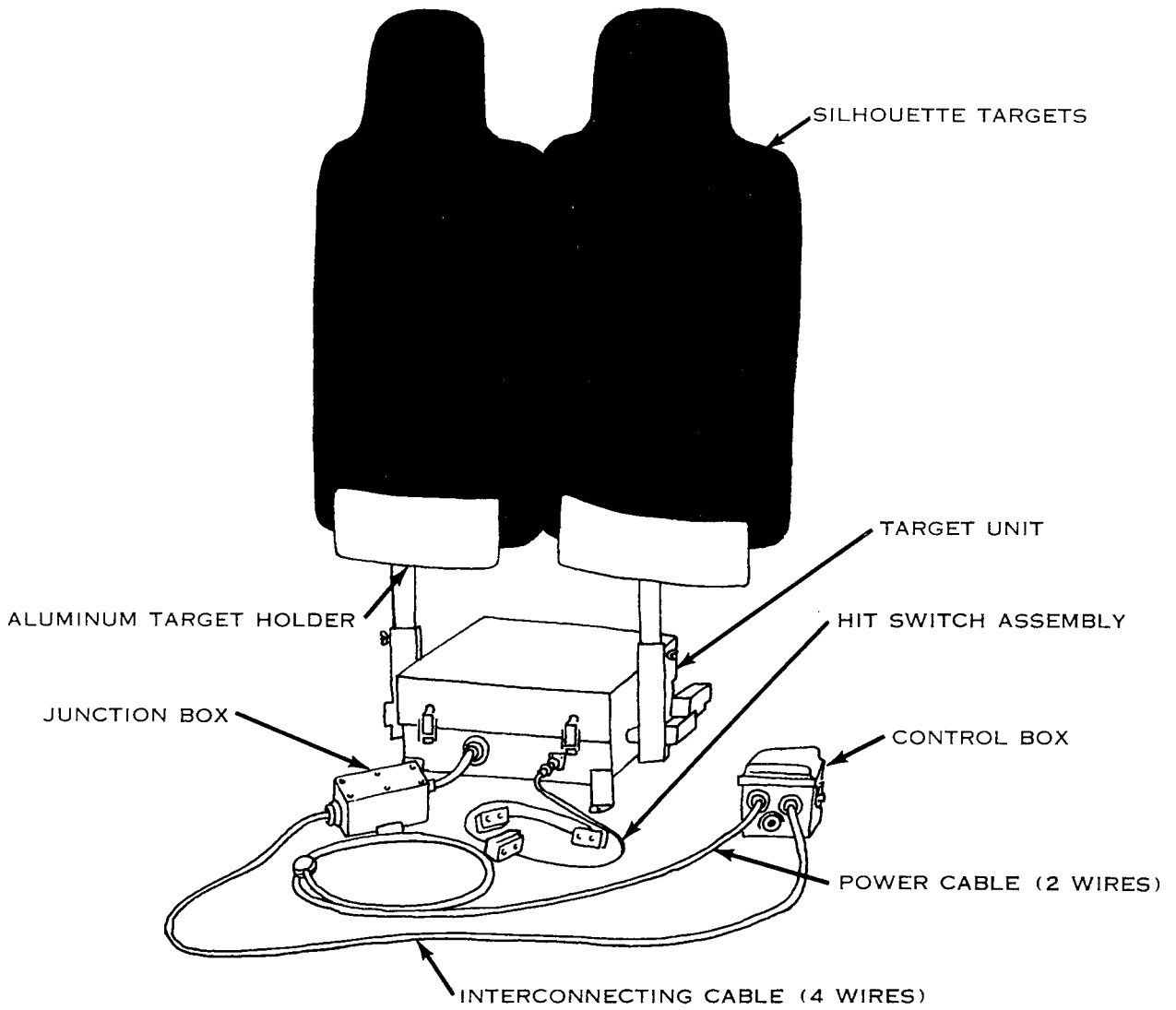


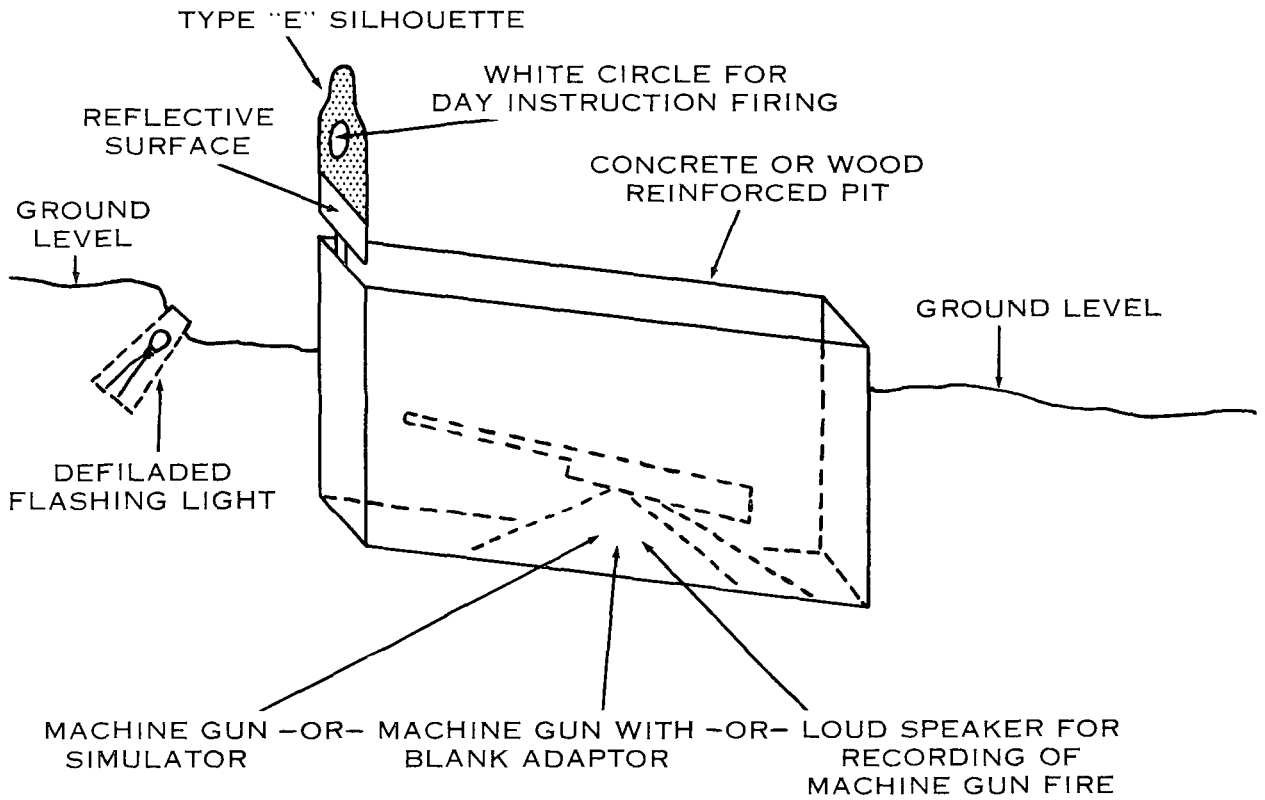
Figure 96. A method of setting up targets to represent a linear formation.



*Figure 97. Manually operated pop-up target mechanism.*



*Figure 98. Electrically controlled and scored pop-up target 3C52b.*



*Figure 99. Flashing target for automatic riflemen and for grenadiers with practice ammunition.*

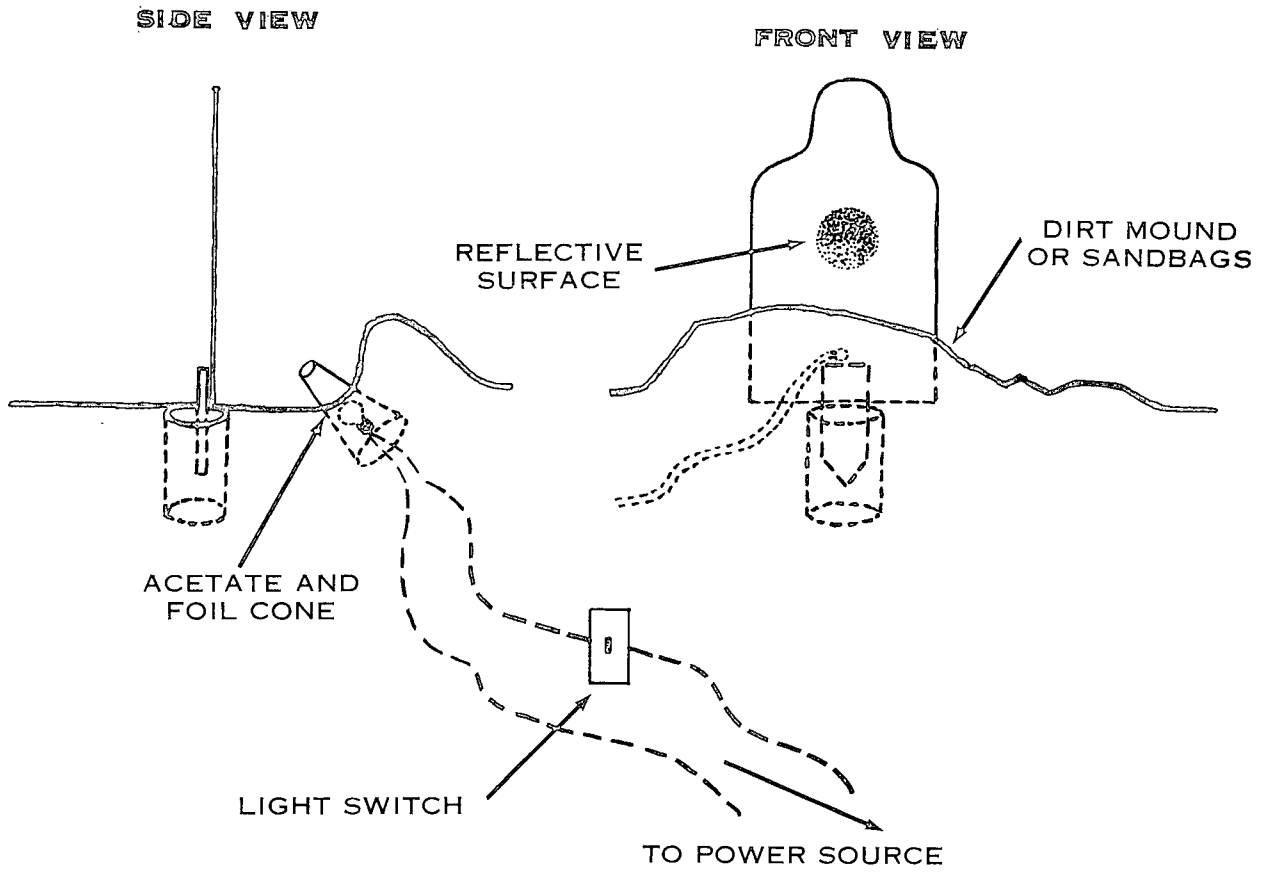


Figure 100. Flashing target device for night assault range.

## INDEX

	Paragraph	Page		Paragraph	Page
Alinement, during night assault.....	58	54	Critique—Continued		
Alternate position.....	75	66	Defensive night firing.....	50, 52	50, 52
Ammunition.....	app. II	102	Field target firing.....	33	31
Ammunition conservation, night defense.	45	46	Landscape target firing.....	38	39
Application firing:			Danger space.....	12	9
Assault, night.....	66	60	Defense.....	82-85	72
Defensive, night.....	51	51	Conduct of (day).....	84	89
Application of fire.....	14-20	15	Conduct of (during periods of limited visibility).....	85	92
Area target.....	19	19	Preparation for.....	83	72
Column target.....	18	18	Distribution of fire.....	16	16
Linear target.....	17	16	Assault (day).....	22	22
Night defense.....	43	44	Assault (night).....	61	57
Point target.....	19	19	Column target.....	18	18
Area target.....	15	15	Defense (day).....	84	89
Arm-and-hand signals.....	80, 81	71, 72	Defense (night).....	44	46
Assault:			Linear target.....	17	16
Day.....	90	95	Field target firing.....	29-33	28
Night.....	91	95	Conduct of training.....	33	31
Assault fire:			Firing exercises.....	32	31
Day.....	22	22	Range facilities.....	31	28
Night.....	56-61	53	Final coordination line.....	74, 87	63, 93
Assembly area.....	90	95	Final protective fires.....	75	66
Attack.....	86-91	92	Fire and maneuver.....	74	63
Conduct of (day).....	88	93	Fire and movement.....	74, 89	63, 94
Night.....	87, 91	93, 95	Fire control.....	23-28	22
Position.....	74	63	Methods.....	24	22
Preparation for (day).....	87	93	Night defense.....	44	46
Automatic rifle capabilities.....	21	22	Fire commands.....	25	23
Battle drill.....	89	94	Elements.....	26	24
Beaten zone.....	12	9	Formal.....	27	26
Casualty radius.....	12	9	Informal.....	28	27
Classes of fire.....	13	15	Firing positions:		
Close defensive fires.....	75	66	Assault (day).....	22	22
Column target.....	15	15	Assault (night).....	57	54
Concentration of fire.....	16	16	Forward edge of the battle area.....	75	66
Concurrent training:			Frontage.....	75	66
Assault night firing.....	66	60	Instruction firing:		
Defensive night firing.....	49, 51	48, 51	Assault night.....	64	57
Field target firing.....	33	31	Defensive night.....	49	48
Landscape target firing.....	38	39	Keeping fire down (assault night firing).....	60	54
Conduct of training (general).....	2	3	Landscape target firing.....	34-38	37
Assault night firing.....	62-67	57	Conduct of training.....	38	39
Defensive night firing.....	49-52	48	Range facilities.....	35	38
Field target firing.....	33	31	Scoring.....	37	39
Landscape target firing.....	38	39	Weapons and zeroing.....	36	38
Consolidation of the objective.....	74, 88	63	Lateral distance measurement.....	10	7
Contact point.....	75	66	Line of departure.....	74	63
Coordinating points.....	75	66	Linear target.....	15	15
Critique:					
Assault night firing.....	65, 67	60, 61			

	Paragraph	Page		Paragraph	Page
Listening post.....	75, 85	66, 92	Scoring—Continued		
Long-range fires.....	75	66	Landscape target firing.....	37	39
Night attack.....	91	95	Proficiency firing:		
Objective.....	74	63	Assault (night).....	70	61
Consolidation.....	87, 90	93, 95	Defensive (night).....	55	53
Reorganization.....	87, 90	93, 95	Sector of fire.....	75	66
Observation post.....	75	66	Simulators.....	31	28
Phase line.....	74	63	Sniping.....	21	22
Phases of instruction:			Speed of movement, night assault.....	58	54
Assault night firing.....	62	57	Squad assault night firing:		
Defensive night firing.....	47	48	Application firing.....	66	60
Technique of fire (day).....	5	6	Application firing critique.....	67	61
Point of departure.....	74	63	Fundamentals.....	56-61	53
Point target.....	15	15	Instruction.....	62-67	57
Prerequisites:			Instruction firing critique.....	65	60
Technique of fire (day).....	3	4	Instruction firing exercises.....	64	57
Technique of fire during periods of limited visibility.	40	42	Proficiency firing.....	70	61
Primary position.....	75, 83	66, 72	Range facilities.....	63	57
Principal direction of fire.....	75	66	Squad column.....	78	71
Probable line of deployment.....	74	63	Squad defensive night firing:		
Proficiency firing:			Application firing.....	51	51
Assault night.....	68-70	61	Application firing critique.....	52	52
Defensive night.....	53-55	53	Fundamentals.....	41-46	42
Range determination.....	7	6	Instruction.....	47-52	48
Appearance of objects method.....	9	7	Instruction firing critique.....	50	50
Exercises.....	33	31	Instruction firing exercises.....	49	48
100-meter unit of measure method.	8	6	Proficiency firing.....	55	53
Ranges:			Range facilities.....	48	48
Assault night firing.....	63	57	Squad file.....	77	71
Defensive night firing.....	48	48	Squad line.....	79	71
Field target firing.....	31	28	Supplementary position.....	75, 83	66, 72
Landscape target firing.....	35	38	Surveillance of the squad sector:		
Proficiency firing:			Defense (day).....	83	72
Assault night.....	69	61	Defense (night).....	42	43
Defensive night.....	54	53	Tactical application:		
Rate of fire.....	16	16	Technique of fire (day).....	82-84, 86-90	72, 92
Release point.....	74	63	Technique of fire (night).....	85, 91	92, 95
Reloading.....	59	54	Targets:		
Reorganization on the objective.....	74, 88	63, 93	Assault night firing.....	63	57
Rifle squad.....	2	3	Defensive night firing.....	48	48
Safety.....	app. III	104	Field target firing.....	31	28
Scoring:			Landscape target firing.....	35	38
Assault night firing.....	67	61	Terms:		
Defensive night firing.....	52	52	Attack.....	74	63
Field target firing.....	33	31	Defense.....	75	66
			Training aids.....	app. IV	107
			Training devices.....	app. V	114
			Trajectory.....	12	9

By Order of the Secretary of the Army:

EARLE G. WHEELER,  
*General, United States Army,*  
*Chief of Staff.*

Official:

J. C. LAMBERT,  
*Major General, United States Army,*  
*The Adjutant General.*

Distribution:

*Active Army:*

DCSPER (2)	MFSS (1)
DCSLOG (2)	USA Ord Sch (1)
DCSOPS (2)	USAES (1)
ACSI (2)	USAQMS (1)
CNGB (2)	USATSCH (1)
Ofc Res Comp (2)	USASCS (1)
CRD (1)	UASCMICSCH (1)
COA (1)	USACHS (1)
CINFO (1)	Armies (5)
TIG (1)	Corps (3)
USAMC (5)	Div (10)
UASCDC (10)	Div Arty (1)
USCONARC (20)	Bde (5)
ARADCOM (2)	Regt/Gp (1)
ARADCOM Rgn (2)	Inf BG (5)
LOGCOMD (1)	Bn (5)
TJAGSA (1)	Co/Btry (5)
PMGS (1)	

*NG:* State AG (3); units—same as active Army except allowance is one copy to each unit.

*USAR:* Same as active Army.

For explanation of abbreviations used, see AR 320-50.